

sMAX04BM sCMOS Camera Manual

Version 1.0
2024.05.24



Camera Model	sMAX04BM	sMAX04BM-U100	sMAX04BM-CL100
Data Interface	USB3	USB3	CameraLink
FPS/Resolution	72.5fps@2048x2048 72.5fps@1024x1024	89fps@2048x2048 100fps@1024x1024	108fps@2048x2048 108fps@1024x1024
ADC 11bit	supported	supported	supported
ADC 11bit High Speed Mode	non-supported	supported	supported
PGA Gain	adjustable	non-adjustable	adjustable

ADC 11bit High Speed Mode: Higher frame rate, but the conversion gain is not adjustable.

All materials related to this publication are subject to change without notice and are copyrighted by Touptek Photonics.

Please download the latest version from touptek.com.

content

sMAX04BM sCMOS Camera Manual	1
1 The basic characteristics of camera.....	1
2 Camera parameters and performance	2
2.1 Camera Specification	2
2.2 Sensor Quantum Efficiency	3
2.3 Camera capture mode	3
2.4 DDR3 buffer	4
2.5 Binning	4
2.6 Conversion Gain.....	4
2.7 DC12V power supply and cooling system	4
2.8 Filter.....	4
3 Dimension and layout of camera	6
3.1 Dimension of the camera	6
3.2 Camera Ports For Connection and Power Supply	6
3.3 The packing information	8
4 External IO connector and electrical characteristics	11
4.1 Pin signal	11
4.2 I/O electrical characteristics.....	11
4.2.1 <i>Opto-isolated input circuit (line0)</i>	11
4.2.2 <i>Opto-isolated output circuit (line1)</i>	11
4.2.3 <i>Input and output I/O circuit (line2/line3)</i>	12
5 Cooling.....	15
6 sMAX04BM Camera application	16
6.1 Trigger Mode and its Configuration	16
6.1.1 <i>Video mode and Trigger mode</i>	16
6.1.2 <i>Trigger Sources and their capture style</i>	16
6.1.3 <i>The trigger capture and IO Control configurations</i>	18
6.2 Application installation	22
6.3 Introduction to ToupView	22
6.3.1 <i>User interface design</i>	23
6.3.2 <i>Professional Camera Control Sidebar</i>	23
6.3.3 <i>Professional and practical image processing functions</i>	24
6.3.4 <i>Super compatibility</i>	24
6.3.5 <i>Basic hardware requirements</i>	24
6.4 Software development instructions	24
6.4.1 <i>SDK description</i>	24
6.4.2 <i>SDK support platform</i>	24
6.4.3 <i>Introduction to SDK content</i>	25
6.4.4 <i>Third-party interface software</i>	27
7 sMAX04BM-CL100 Camera application.....	28
7.1 Connection to the CameraLink.....	28
7.2 Software installation.....	28

7.2.1	<i>Install SDK</i>	28
7.2.2	<i>Install options</i>	28
7.2.3	<i>Install the driver</i>	29
7.3	Configure the Delsa capture card	29
7.3.1	<i>Serial port configuration</i>	29
7.3.2	<i>CameraLink mode configured</i>	30
7.3.3	<i>Configuring CameraLink Receiving</i>	31
7.3.4	<i>CameraLink Receiving the configuration content</i>	32
7.4	Using GenIcam.....	33
7.4.1	<i>Communication Settings</i>	33
7.5	Description of GenIcam	34
7.5.1	<i>Device Information and control</i>	35
7.5.2	<i>Image Format Controls</i>	35
7.5.3	<i>TEC Ctrl</i>	35
7.5.4	<i>Trigger ctrl</i>	36
7.6	Camera Commands.....	37
7.6.1	<i>Basic Formats</i>	37
7.6.2	<i>Dedicated Part Format</i>	37
7.6.3	<i>Definition of each register</i>	38
7.7	SDK & CLView application	41
7.7.1	<i>SDK</i>	41
7.7.2	<i>CLView application</i>	41
7.7.3	<i>CLCtrl software</i>	42

1 The basic characteristics of camera

sMAX04BM is powered by GSENSE2020BSI 1.2-inch image sensor. In view of the inherent thermal noise of the sensor, an efficient cooling module is specially designed to make the camera sensor work at 35-40 degrees lower than the ambient temperature. An anti-fogging mechanism is designed to prevent the fogging of the sensor and filter surface at low temperature. sMAX04BM video and image data is transmitted through the USB3 or CameraLink ultra high speed transfer interface for fast preview.

The basic characteristics of sMAX04BM Camera are listed below:

- GSENSE2020BSI CMOS sensor
- 200nm-1100nm Wide spectral range
- Supports ultraviolet, visible, and near-infrared band applications
- Precise temperature control, the temperature difference can reach 40 degrees Celsius below the ambient temperature
- Resolution: 2048 x2048
- 6.5um pixel size
- Rolling shutter
- USB3 / CameraLink interface
- 11-bitADC / 12-bit ADC / 16-bit combined HDR
- Support 11bit high-speed read mode, USB3 / CameraLink frame rate of 89fps / 108fps
- 4Gb RAM
- Support HCG / LCG / HDR mode
- Support Global Reset mode
- Support 2-CMS low noise mode
- Ultra-low readout noise: 1.0e-(2-CMS Mode)
- Maximum SNR: 47.3dB(LCG)
- Dynamic Range: 86dB(16BIT HDR12HL) / 91.8dB(16BIT HDR11HL)
- Supports external I/O trigger control
- Compact structure 80*80*101.5mm

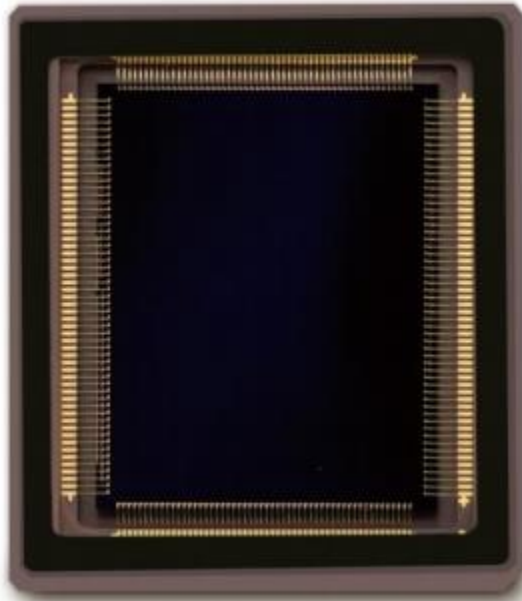

2 Camera parameters and performance

2.1 Camera Specification

Table 1 sMAX04BM camera specification

Parameter		Model	sMAX04BM	sMAX04BM-U100	sMAX04BM-CL100
Camera					
Sensor model			GSENSE2020BSI		
Sensor type			CMOS		
Spectral range			200nm - 1100nm		
pixel size			6.5 μm x 6.5 μm		
Target size			1.2"		
Resolution			2048 x 2048		
Frame Rate			72.5fps@2048x2048 72.5fps@1024x1024	89fps@2048x2048 100fps@1024x1024	108fps@2048x2048 108fps@1024x1024
Memory			512MB (4Gb)		
Conversion gain	11bit		1.03		
	12bit		0.42(HCG) 13.33(LCG)		
	12bit CMS		0.43		
	12bit Global reset		0.44(HCG) 1.92(LCG)		
	HDR 11HL		0.58		
	HDR 12HL		0.54		
Dynamic Range	11bit		61.38dB		
	12bit		59.73dB(HCG) 67.17dB(LCG)		
	12bit CMS		64.12dB		
	12bit Global reset		58.63dB(HCG) 61.27dB(LCG)		
	HDR 11HL		91.83dB		
	HDR 12HL		86.02dB		
Read noise	11bit		1.69e-		
	12bit		1.72e-(HCG) 23.25e-(LCG)		
	12bit CMS		1.07e-		
	12bit Global reset		2.08e-(HCG) 6.62e-(LCG)		
	HDR 11HL		0.97e-		
	HDR 12HL		1.78e-		
Full well charge	11bit		1.98ke-		
	12bit		1.67ke-(HCG) 53.07ke-(LCG)		
	12bit CMS		1.71ke-		
	12bit Global reset		1.78ke-(HCG) 7.66ke-(LCG)		
	HDR 11HL		37.85ke-		
	HDR 12HL		35.56ke-		
SNR	11bit		32.97dB		
	12bit		32.22dB(HCG) 47.25dB(LCG)		
	12bit CMS		32.34dB		
	12bit Global reset		32.49dB(HCG) 38.85dB(LCG)		
	HDR 11HL		45.78dB		
	HDR 12HL		45.51dB		
Sensitivity			1.1x10 ⁸ e-/((W/m ²).s)@550nm		
Dark current			Typical: 0.45e-/s/pix@ -30°C die temp		
QE			95%@560nm		
Exposure time range			12us-300s	12us-10s	12us-10s
Gain Range			1x – 21x	1x	1x – 21x
Shutter mode			Rolling shutter / Global reset		
Binning mode			Software 2x2, 3x3, 4x4, Hardware FPGA 2x2		

Data interface	USB3.0	USB3.0	CameraLink
Digital I/O	One optical-coupling isolated input, one optical-coupling isolated output, tow non-isolated input and output		
Data Format	Mono 11 / Mono 12 / Mono 16		
Cooling temperature difference	Below room temperature 40 degrees Celsius		
General parameters			
Power supply	DC12V power supply		
Power consumption	<25W		
Temperature	Working temperature -30 ~ 60 °C, storage temperature - 40 ~ 85 °C		
Humidity	20%-80% , non-condensing		
Size	80*80*101.5		
Weight	860g		
Lens mount	C-mount interface		
Software	Provide Complete SDK (software development kit) / ToupView / SDK development kit and CL View software based on Delsa acquisition card		

2.2 Sensor Quantum Efficiency

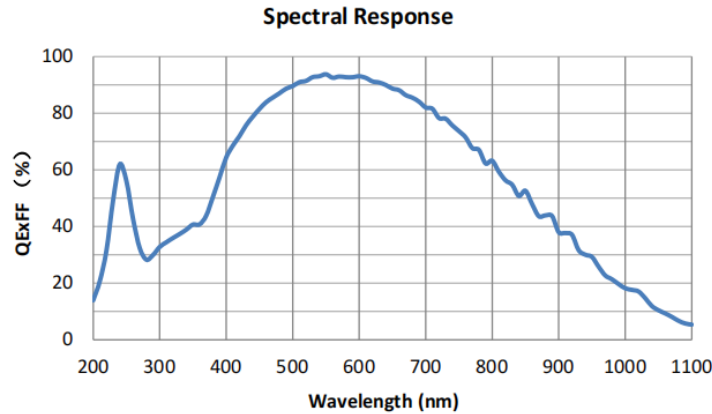

Figure 1 The spectral QE of GSENSE2020BSI

2.3 Camera capture mode

Table 2 Camera capture mode

Pixel format	Sensor operat mode	HCG/LCG	Support model		
			sMAX04BM	sMAX04BM-U100	sMAX04BM-CL100
RAW8	ADC 11bit	√	√	×	√
	ADC 11bit High Speed	×	×	√	√
RAW11	ADC 11bit	√	√	×	√
	ADC 11bit High Speed	×	×	√	√
RAW12	ADC 12bit	√	√	√	√
	2-CMS	×	√	√	√
	Global Reset	√	√	√	√
RAW16 (HDR 11HL)	ADC 11bit	×	√	√	√
RAW16 (HDR 12HL)	ADC 12bit	×	√	√	√

HDR 11HL: ADC 11Bit HCG + ADC 11Bit LCG = HDR 16Bit

HDR 12HL: ADC 12Bit HCG + ADC 12Bit LCG = HDR 16Bit

2-CMS Low Noise Mode.

2.4 DDR3 buffer

Camera has a built-in 512MB (4Gb) DDR3 buffer, which can effectively the camera does not lose frames when working.

2.5 Binning

sMAX04BM supports additive or averaged 1x1 to 8x8 digital binning, and averaged 1x1 to 2x2 hardware binning. Hardware binning can achieve higher frame rates than software binning.

sMAX04BM-CL100 supports averaged 1x1 to 2x2 hardware binning.

2.6 Conversion Gain

Camera supports HCG and LCG mode. HCG has low Readout Noise, LCG has higher Full Well. Users can choose different modes according to different applications.



Figure 2 HCG and LCG mode

2.7 DC12V power supply and cooling system

When the DC12V power supply is plugged in, both the camera cooling system and the imaging system use a unified 12V power supply.

When the DC12V power supply is disconnected, the camera cant work.

The cooling system is TEC cooling. It uses an external heat dissipation structure and a fan to assist heat dissipation. The working temperature can be adjusted to a specific value, and the effective cooling temperature can be lower than the ambient temperature by 35 - 40 °C. The efficient cooling system guarantees extremely low dark current levels.

The TEC system is controlled by PID algorithm, so that the TEC can be accurately adjusted to the target temperature, and the temperature deviation is 0.1°C.

2.8 Filter

The sMAX04BM uses UV Quartz glass JGS2 filter with a filter size of 39.00mm*29.00mm*1.10mm. The transmittance curve is shown below.

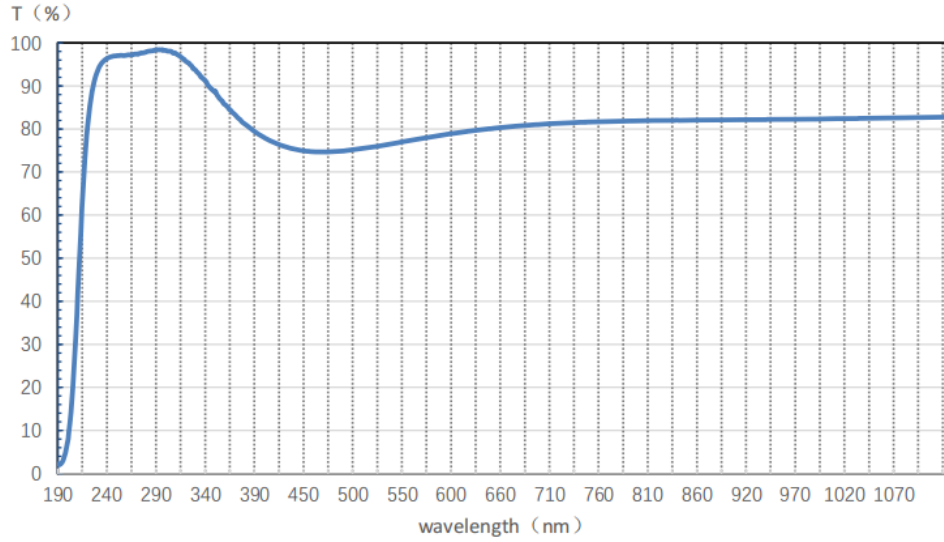

Figure 3 Transmittance curve

Table 3 Transmittance

λ (nm)	T (%)	λ (nm)	T (%)	λ (nm)	T (%)	λ (nm)	T (%)
190	2.28	420	75.91	650	80.51	880	82.14
200	8.01	430	75.34	660	80.73	890	82.15
210	41.85	440	74.92	670	80.91	900	82.17
220	80.82	450	74.71	680	81.07	910	82.18
230	93.45	460	74.65	690	81.17	920	82.20
240	96.42	470	74.73	700	81.33	930	82.23
250	97.01	480	74.91	710	81.43	940	82.27
260	97.12	490	75.16	720	81.55	950	82.28
270	97.40	500	75.44	730	81.61	960	82.28
280	97.92	510	75.80	740	81.67	970	82.34
290	98.40	520	76.18	750	81.74	980	82.37
300	98.19	530	76.58	760	81.76	990	82.39
310	97.43	540	77.01	770	81.84	1000	82.42
320	95.71	550	77.43	780	81.90	1010	82.45
330	93.57	560	77.79	790	81.91	1020	82.49
340	91.11	570	78.18	800	81.96	1030	82.51
350	88.78	580	78.57	810	81.99	1040	82.55
360	85.62	590	78.91	820	82.01	1050	82.60
370	83.27	600	79.25	830	82.05	1060	82.63
380	81.11	610	79.55	840	82.04	1070	82.68
390	79.34	620	79.82	850	82.08	1080	82.73
400	77.94	630	80.06	860	82.09	1090	82.76
410	76.84	640	80.36	870	82.11	1100	82.77

3 Dimension and layout of camera

3.1 Dimension of the camera

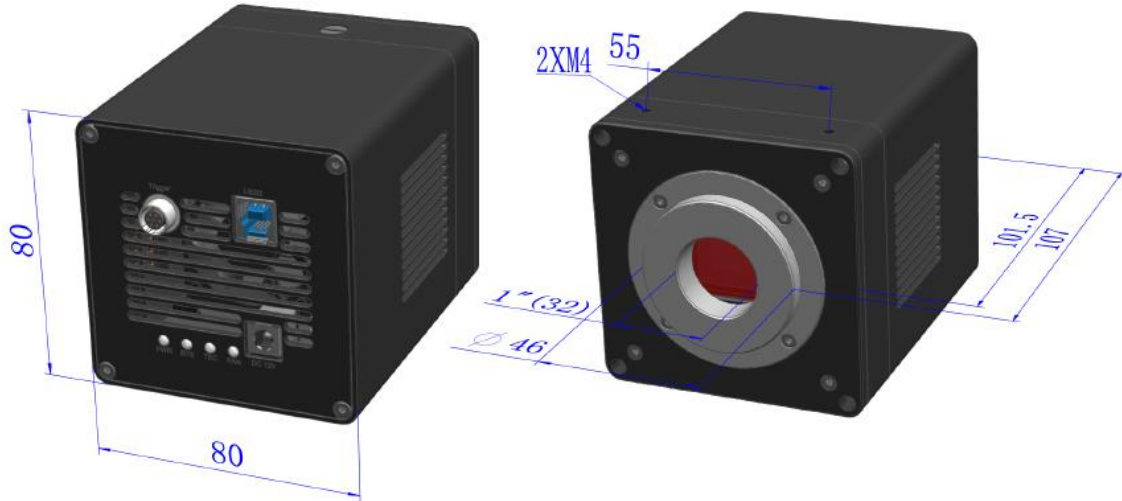

Figure 4 The dimensions of the sMAX04BM

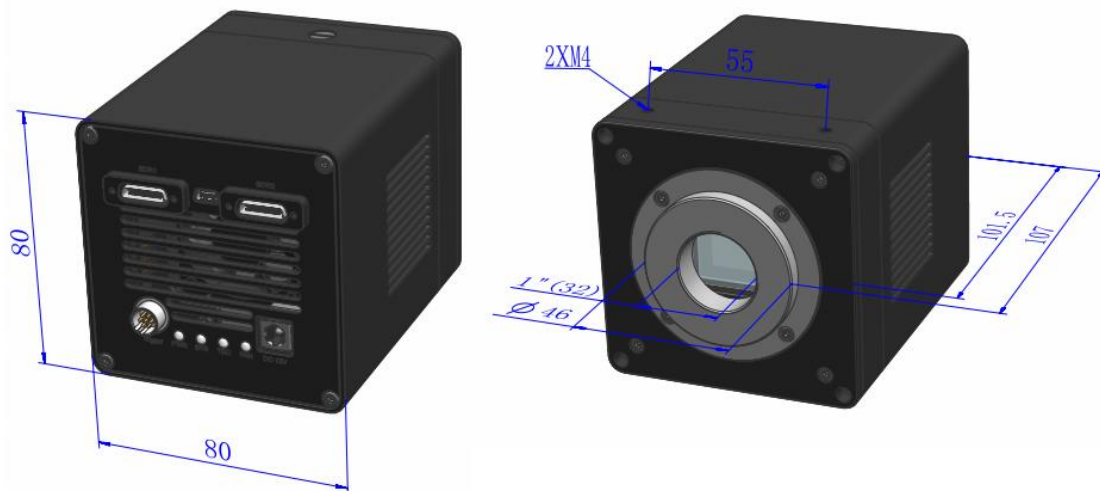

Figure 5 The dimensions of the sMAX04BM-CL100

Table 4 The Dimension of camera

Parameter	Specification
Dimension	80*80*101.5mm
Camera lens interface	Standard C mount

3.2 Camera Ports For Connection and Power Supply

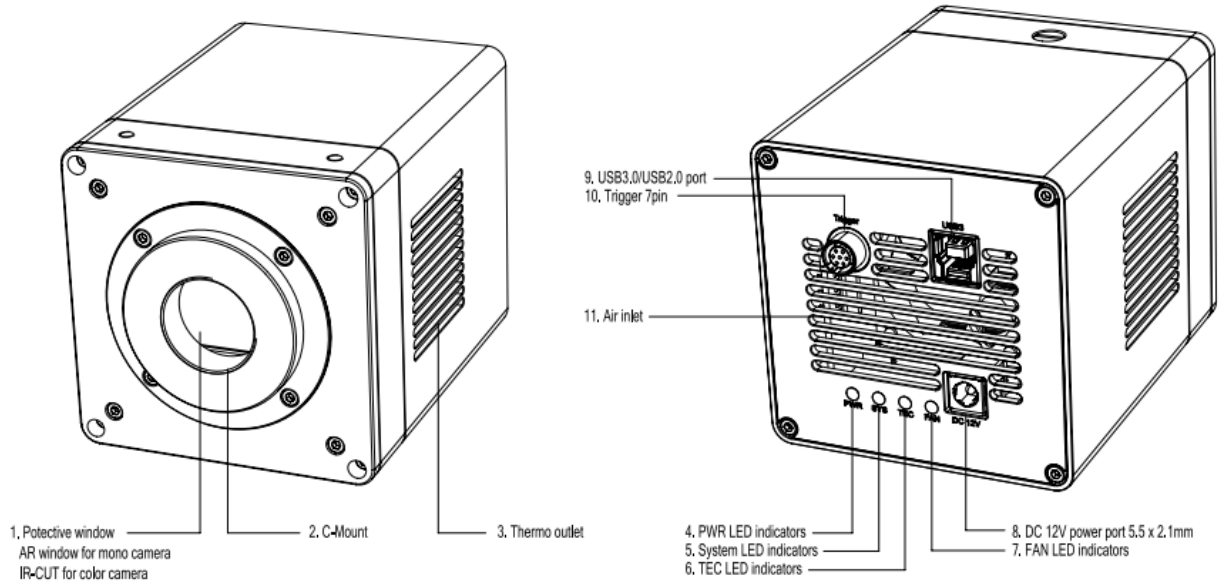

Figure 6 sMAX04BM ports

Table 5 sMAX04BM ports

Item	Specification
1	Filter window, AR window for mono camera
2	C mount
3	Thermo outlet
4	Power LED indicators
5	System LED indicators
6	TEC LED indicators
7	FAN LED indicators
8	DC 12V power port, 5.5 × 2.1mm
9	USB 3.0/ USB 2.0 port
10	Trigger 7PIN
11	Air inlet

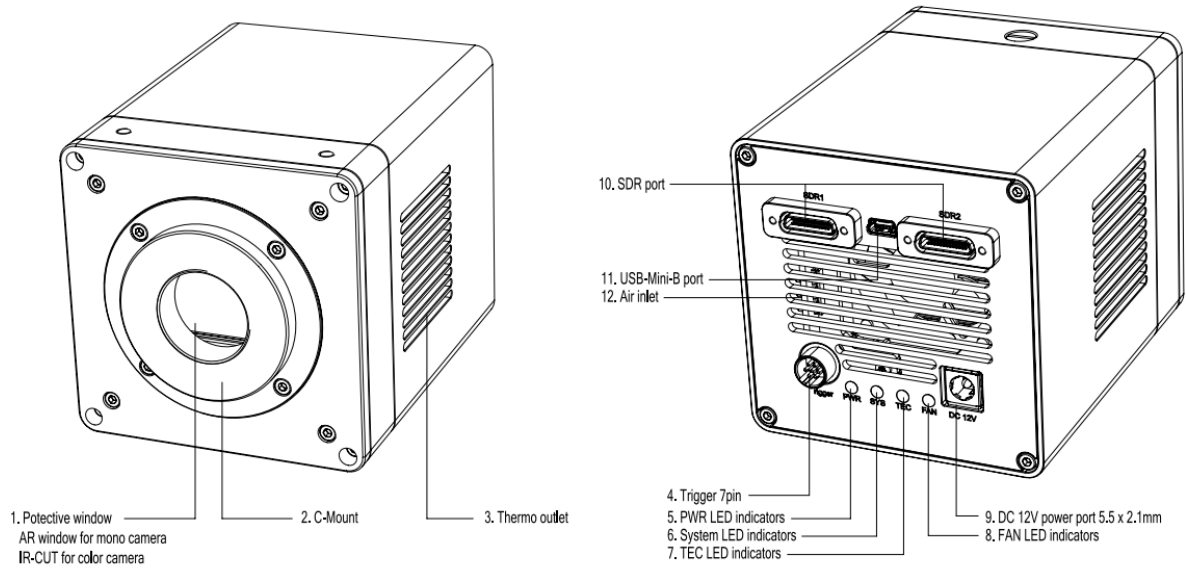

Figure 7 sMAX04BM-CL100 ports

Table 6 sMAX04BM-CL100 ports

Item	Specification
1	Filter window,AR window for mono camera
2	C mount
3	Thermo outlet
4	Trigger 7PIN
5	Power LED indicators
6	System LED indicators
7	TEC LED indicators
8	FAN LED indicators
9	DC 12V power port, 5.5 × 2.1mm
10	CameraLink port
11	USB-Mini-B port
12	Air inlet

3.3 The packing information



Figure 8 The packing information of the sMAX04BM

Table 7 The packing information of the sMAX04BM

Standard Package			
A	Carton L:50cm W:30cm H:30cm (20pcs, 12~17Kg/ carton), not shown in the photo(TBD)		
B	3-A safety equipment case: L:28cm W:23cm H:15cm (1pcs, 2.8Kg/ box); Carton size:L:28.2cm W:25.2cm H:16.7cm(TBD)		
C	One sMAX04BM camera		
D	Drying tube and desiccant		
E	Power adapter: input: AC 100~240V 50Hz/60Hz, output: DC12 V 3A		
F	High-Speed USB3.0 A male to B male gold-plated connectors cable /1.5m		
G	IO cable		
H	CD (Driver & utilities software, Ø12cm)		
Optional Accessory (Not shown in the Photo)			
I	Adjustable lens adapter	C-mount to Dia.23.2mm eyepiece tube (Please choose 1 of them for your microscope)	108001/AMA037 108002/AMA050 108003/AMA075 108004/AMA100
J	Fixed lens adapter	C-mount to Dia.23.2mm eyepiece tube (Please choose 1 of them for your microscope)	108005/FMA037 108006/FMA050 108007/FMA075 108008/FMA100
Note: For I and J optional items, please specify your camera type(C-mount, microscope camera or telescope camera), Touptek engineer will help you to determine the right microscope or telescope camera adapter for your application;			
K	108015(Dia.23.2mm to 30.0mm ring)/Adapter rings for 30mm eyepiece tube		
L	108016(Dia.23.2mm to 30.5mm ring)/ Adapter rings for 30.5mm eyepiece tube		
M	Calibration kit	106011/TS-M1(X=0.01mm/100Div.); 106012/TS-M2(X,Y=0.01mm/100Div.); 106013/TS-M7(X=0.01mm/100Div., 0.10mm/100Div.)	



Figure 9 The packing information of the sMAX04BM-CL100

Table 8 The packing information of the sMAX04BM-CL100

Standard Packing information	
A	3-A equipment case: L:28cm W:23cm H:15.5cm (1pcs, 2.8Kg/ box)
B	One sMAX04BM-CL100 Camera
C	Power cord. National standard, American standard, European standard, British standard power cord for choosing
D	Power adapter: input: AC 100~240V 50Hz/60Hz, output: DC12 V 3A
E	One USB-Mini cable
F	One external trigger control cable
G	2 CameraLink cables(Optional Accessory)
H	capture card(Optional Accessory)

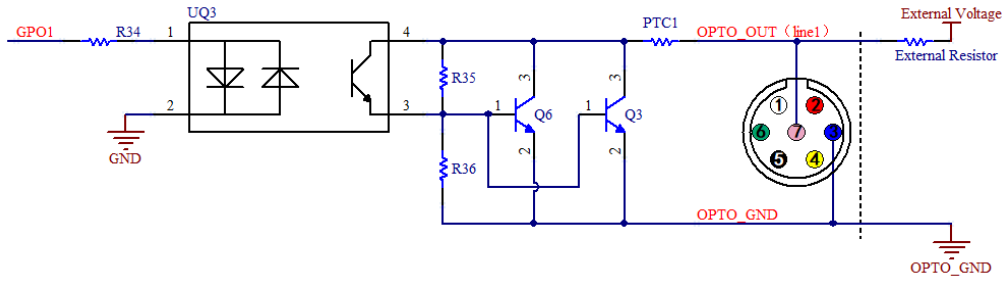

Figure 12 Optocoupler output circuit

The opto-isolated output maximum current is 30mA.

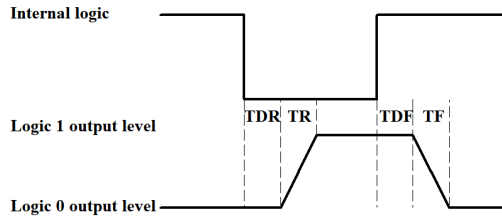

Figure 13 Output logic levels

The electrical characteristics of the opto-isolated output (external voltage 5V, external resistor 1K) are shown in Table 10.

Table 10 Opto-isolated output signal's electrical characteristics

Parameter name	Parameter notation	Parameter value
Output logic low	VL	742mV
Output logic high	VH	4.134V
Output rise time	TR	4us
Output fall time	TF	1.8us
Output rise delay	TDR	12us
Output fall delay	TDF	2us

The output of the corresponding output current and VL when using different voltages and resistors in external circuit are shown in Table 11.

Table 11 Opto-isolated output logic's low levels parameters

External voltage	External resistor	VL	Output current
3.3V	1KΩ	510mV	2.82mA
5V	1KΩ	742mV	4.31mA
12V	2.4KΩ	795mV	4.68mA
24V	4.7KΩ	850mV	4.97mA

4.2.3 Input and output I/O circuit (line2/line3)

The non-isolated configurable input and output I/O circuits are shown in Figure 14 and Figure 15.

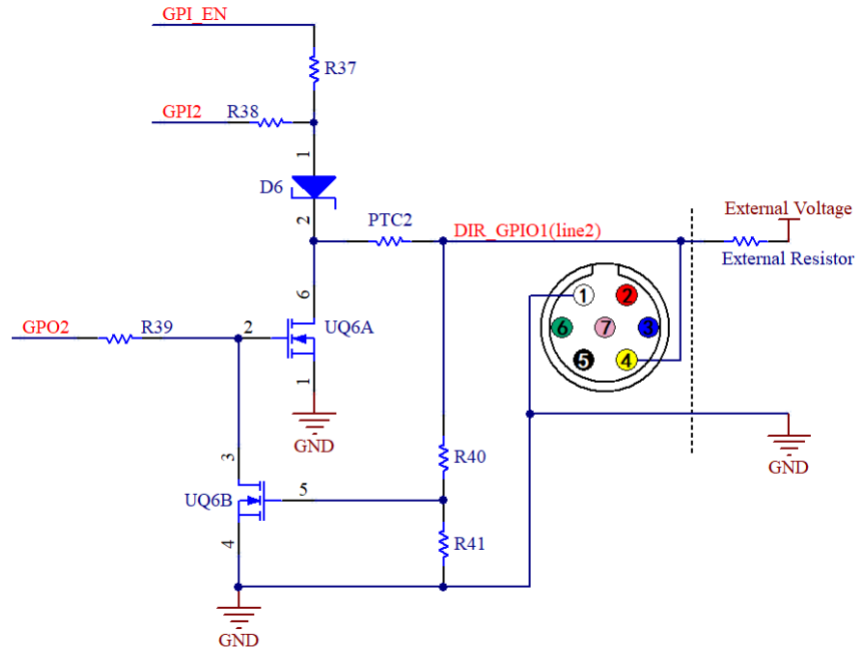

Figure 14 Non-isolated configurable input and output I/O circuit (line2)

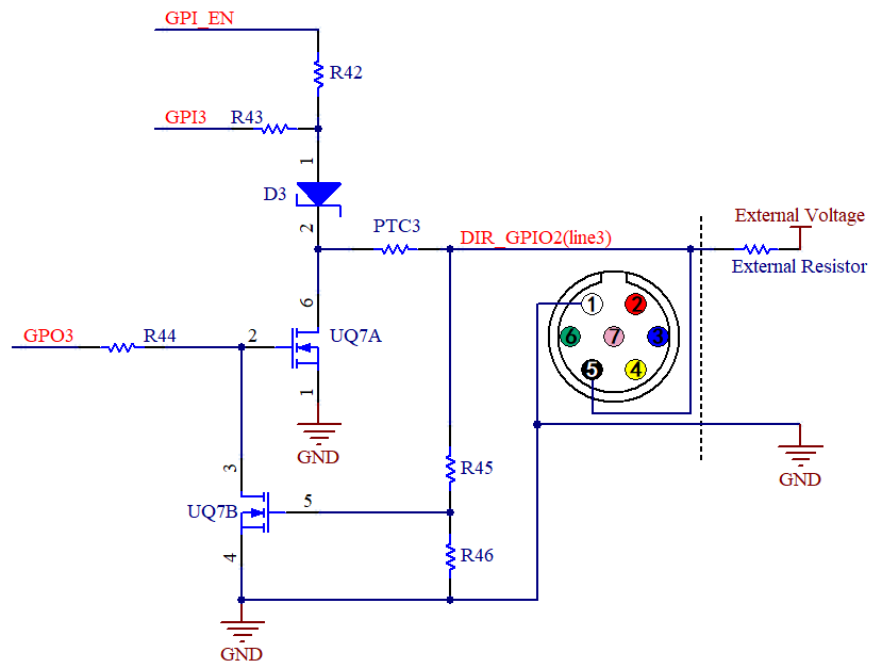

Figure 15 Non-isolated configurable input and output I/O circuit (line3)

1. Line2/line3 is set as input pin

Logic 0 input level: 0~0.6VDC (DIR_GPIO1/DIR_GPIO2 pins)

Logic 1 input level: 2.0~24VDC (DIR_GPIO1/DIR_GPIO2 pins)

Maximum input current: 25mA

When the input level is between 0.6V and 2.0V, the circuit action state is uncertain, please avoid the input voltage

range working in this range.

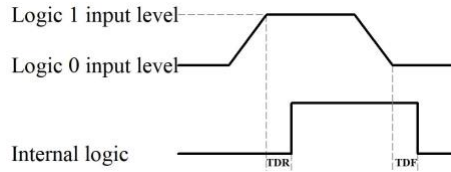

Figure 16 Input logic levels

To prevent damage to the GPIO pins, please connect the pin GND first, and then input voltage to the Line2 pin.

Input rise delay (TDR): 0.02us

Input fall delay (TDF): 0.02us

2.Line2/line3 are set as output pins

The maximum current allowed through this pin is 25mA.

When the ambient temperature is 25 degrees Celsius, the relationship between the external voltage, resistance and low-level valtage output is shown in Table 12.

Table 12 Non-isolated output Logic's low level parameters

External voltage	External resistor	VL (GPIO)
3.3V	1KΩ	0.11V
5V	1KΩ	0.167V
12V	2.4KΩ	0.184V
24V	4.7KΩ	0.385V

The external pull-up voltage is 5V, the pull-up resistor is 1K Ω , and the GPIO is configured to output the logic level and electrical characteristics as shown in Figure 17.

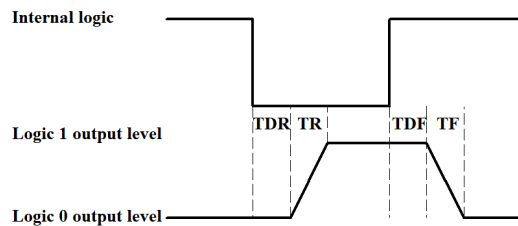

Figure 17 Output logic levels

Table 13 Non-isolated output electrical characteristics

Parameter name	Parameter notation	Parameter value
Output rise time	TR	0.08us
output fall time	TF	0.02us
Output rise delay	TDR	0.1us
Output fall delay	TDF	0.04us

5 Cooling

There is a **Cooling** group on the left sidebar in ToupView. To enable the **Cooling** function, an external 12V power supply is required. By default, the **TEC** is turned on. One can set the **Target Temperature**. After entering the value, click "**Apply**", and the sensor temperature will gradually approach to the **Target Temperature**. At the same time, ToupView can display the current temperature in real time. And the cooling effect can reach about 35-40 degrees lower than the ambient temperature, as shown in Figure 18.

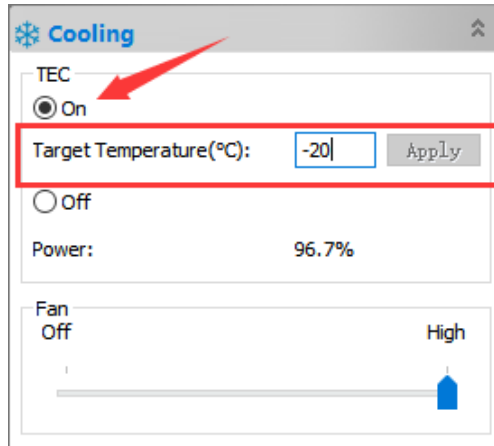

Figure 18 TEC settings

The **Fan** has two gears from **Off** to **High**. When **High**, the **Fan** speed reaches the highest. When **Off**, the **Fan** is turned off, the **TEC** is also turned off, and the power is 0, as shown in Figure 19.

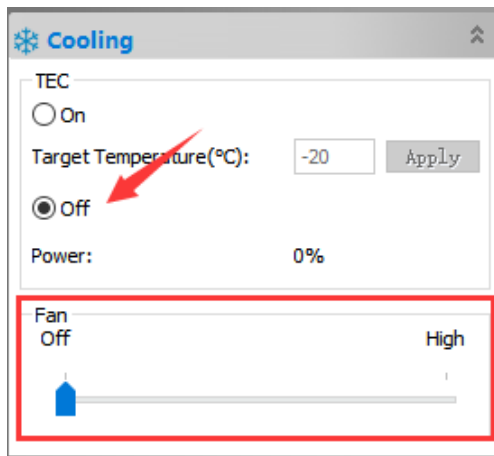

Figure 19 Fan settings

When the **TEC** is turned on, the **Fan** will automatically turn on preventing the abnormal situation such as the housing temperature is too high if the **Fan** stops running when the **TEC** is working; when the **Fan** is turned off, the **TEC** will automatically turn off.

6 sMAX04BM Camera application

6.1 Trigger Mode and its Configuration

6.1.1 Video mode and Trigger mode

The trigger function can be found on the **Capture & Resolution** group on the **Camera Sidebar** in **ToupView**. When the camera is opened, it is in **Video Mode** as shown in Figure 20 on the left. In **Video Mode**, **Auto Exposure**, **Exposure Target**, **Exposure Time** and **Gain** can be set. One can switch to **Trigger Mode** by checking the **Trigger Mode** check box.

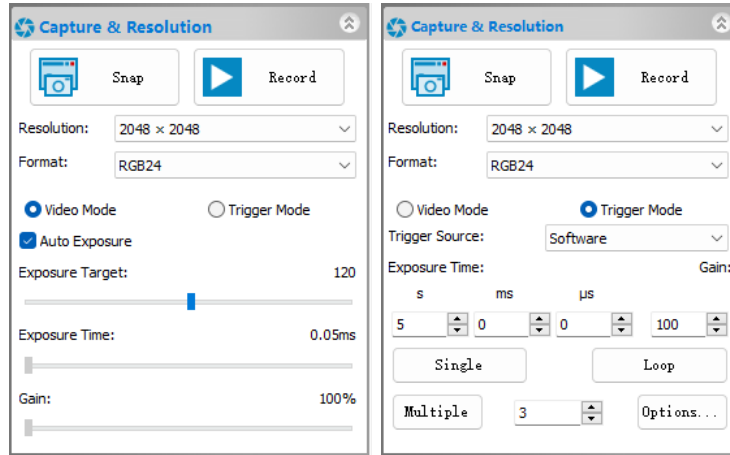

Figure 20 Video Mode and Trigger Mode on the Capture & Resolution group in ToupView

After the **Trigger Mode** is checked, the **Capture & Resolution** group will switch to **Trigger Mode** as shown in Figure 20 on the right. Where, the **Trigger Source**, **Exposure Time**, **Gain**, **Single**, **Loop**, **Multiple**, **Frame Box**, and **Options** can be set.

6.1.2 Trigger Sources and their capture style

The **Trigger Source** can be any external input signal inputted into the camera which is called **Hardware (Trigger Source)**, it can also be a command from the application which is called **Software (Trigger Source)**. For the **Software Trigger Source**, it can be **Single**, **Loop**, **Multiple**, or **Sequence** style. Figure 21 shows the possible **Trigger Sources**. Table 14 shows the designed **Trigger Source** descriptions and possible capture styles for ToupTek camera.

- Isolated input
- GPIO0
- GPIO1
- Counter
- PWM
- Software

Figure 21 Possible Trigger Sources

Table 14 Description of possible Trigger Sources and their capture styles

Trigger Source	Description
Isolated input	Logic 0 input level: 0~2.2VDC; Logic 1 input level: 3.3~24VDC; Maximum input current: 30mA;
GPIO0	Logic 0 input level: 0~0.6VDC (DIR_GPIO0/DIR_GPIO1 pins); Logic 1 input level: 2.0~24VDC (DIR_GPIO0/DIR_GPIO1 pins); Maximum input current: 25mA; If GPIO0 is chosen as Trigger Source , it should be configured as Input in the GPIO Mode 's combo box on the Options>IO Control page;
GPIO1	Logic 0 input level: 0~0.6VDC (DIR_GPIO0/DIR_GPIO1 pins); Logic 1 input level: 2.0~24VDC (DIR_GPIO0/DIR_GPIO1 pins);

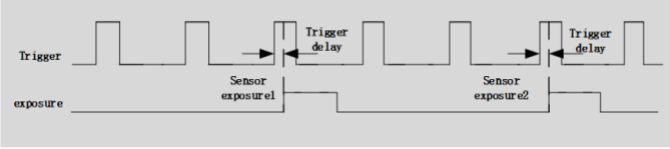
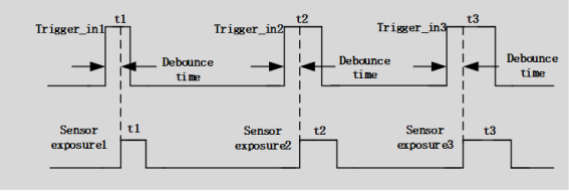
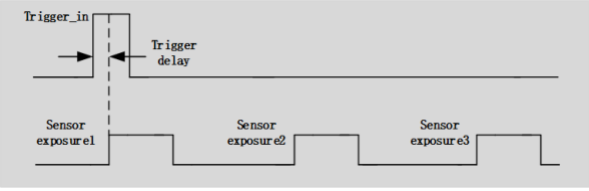
	<p>Maximum input current: 25mA; If GPIO1 is chosen as Trigger Source, it should be configured as Input in the GPIO Mode's combo box on the Options>IO Control page;</p>
<p>Counter</p>	<p>Counter refers to the operation mode in which the camera can divide the frequency of the external input trigger signal through the preset Counter Value and perform image acquisition according to the customer's logic. For example, when the counter value (Counter Value: <input type="text" value="3"/> [1,1023]) is set to 3, the camera needs to receive 3 trigger signals to trigger once;</p>  <p>When Counter is chosen in Trigger Source combo box in the Capture & Resolution group, the Counter Source can be Isolated input, GPIO0 or GPIO1 which can be chosen on Options>IO Control page; If GPIO0 or GPIO1 is chosen in the Counter Source combo box on Options>IO Control page. It should be configured as Input in the GPIO Mode combo box; Check Options>IO Control page's Line Select related items and Counter related items for details;</p>
<p>PWM</p>	<p>PWM refers to the operation mode in which the camera exposure time is controlled by the input trigger signal's pulse width;</p>  <p>PWM Trigger Source can be Isolated input, GPIO0 or GPIO1. If GPIO0 or GPIO1 is chosen in the PWM Source combo box on the Options>IO Control page, it should be configured as Input in the GPIO Mode combo box; Check Options>IO Control page's Line Select related items and PWM related items for details;</p>
<p>Software</p>	<p>When Software trigger is chosen, the client software can send the command through USB3.0 to trigger, acquire and transfer images, In ToupView, Single, Loop, Multiple, or Sequence can be used to send the Software trigger command; If the Plan or Hardware is chosen in the Type combo box on the Options>Sequence page, the Multiple button will switch to Sequence button and the camera will use the Exposure Time and Gain in the Sequence table on this page one by one to capture the specified frames. Check Single, Loop, Multiple, or Sequence on Capture & Resolution group for the Software capture operations; Check Options>Sequence page and Options>Advanced page for the related Sequence and Software capture setup options;</p>
<p>Single</p>	<p>When Single is clicked, the camera will start to capture the image. At the same time the Single button will switch to Stop button. Clicking Stop button to stop the current Single capture operation, the Stop button will switch to Single button again for the next capture operation; Note: 1) The captured frames will always Show in the video window to prevent too many captures; 2) Enabled when Software in the Trigger Source combo box is chosen or Always enable software trigger checkbox is checked on the Options>Advanced property page;</p>
<p>Loop</p>	<p>When Loop is clicked, the camera will start to capture the image continuously and the Loop button will switch to Stop button. Clicking Stop button to stop Loop captures and the Stop button will switch to Loop button for the next Loop capture operation; Note: 1)The captured frames will always Show in the video window to prevent too many captures; 2)Enabled to capture continually when Software in the Trigger Source combo box is chosen or Always enable software trigger checkbox is checked on the Options>Advanced property page;</p>
<p>Multiple</p>	<p>Multiple refers to the operation mode in which the camera receives Software trigger signal or command and exports multiple frames of images. An edit box with spin (we call it Frames Box) is designed and affiliated to the Multiple button (<input type="text" value="Multiple"/> <input type="text" value="3"/> <input type="button" value="Options..."/>) for the setting of the frames to be captured; The Frames Box can be set in the range of 1~ 65535. If the Frames Box is 3, a three-frame image will be captured and exported;</p>  <p>Note: 1) Multiple capture is enabled to capture continually when Software in the Trigger Source combo box is chosen; 2) Multiple capture is enabled when Always enable software trigger is checked on the Options>Advanced property page, no matter whether Trigger Source is Software or Hardware on the Capture & Resolution group; 3) If the Plan or Hardware is chosen in the Type combo box on the Options>Sequence page, the Multiple button</p>

	will switch to Sequence button and the camera will use the Exposure Time and Gain in the Sequence table on this page. The captured frames will be displayed either in Show in the video window , or Show in a new window or Save to disk which can be specified on Options>Output page;
Sequence	<p>When Sequence is clicked, the camera will start to capture the image until the specified frames in the Frames Box are captured. At the same time the Sequence button will switch to Stop button. Clicking Stop button will stop the current Sequence capture and the Stop button will switch to Sequence again for the next Sequence capture operation;</p> <p>Note:</p> <ol style="list-style-type: none"> 1) Switched from Multiple to Sequence to capture the specified frames in the edit box with spin(Frames Box) when Plan or Hardware in the Type combo box is chosen on the Options>Sequence property page; 2) If the Plan or Hardware is chosen in the Type combo box on the Options>Sequence page, the Sequence button will be enabled and the capture will use the Exposure Time and Gain in the Sequence table list below one by one on the Options>Sequence page; 3) If the Plan or Hardware is chosen in the Type combo box on the Options>Sequence page and Always enable software trigger is checked on the Options>Advanced property page, the Sequence button will not switch to Multiple button and will be enabled only when the still in Sequence enable 4) If the Plan is chosen in the Type combo box on the Options>Sequence page and the Software is chosen in the Trigger Source combo box, the Sequence button will be enabled. 5) If the Hardware is chosen in the Trigger Source combo box, the Sequence button will be disabled, but the Frame Box will still be enabled and the Sequence will switch to the Hardware Sequence capture. One Hardware trigger signal will capture the specified frames on the Frame Box using the Exposure Time and Gain in the Sequence table on Options>Sequence page; 6) Check Options>Sequence page for the related Sequence setup options;

6.1.3 The trigger capture and IO Control configurations

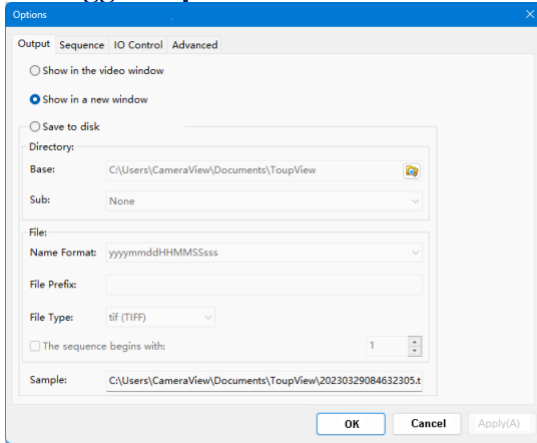

Figure 22 Options>Output page

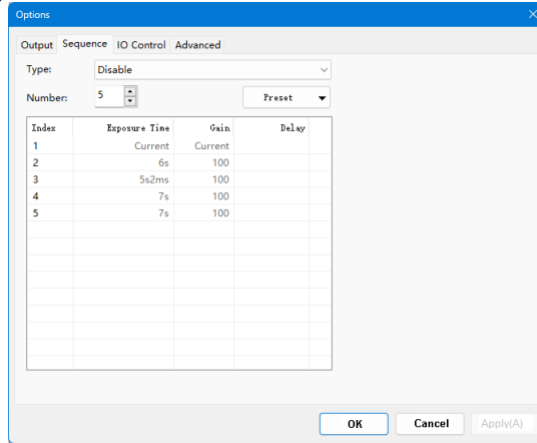

Figure 23 Options>Sequence page

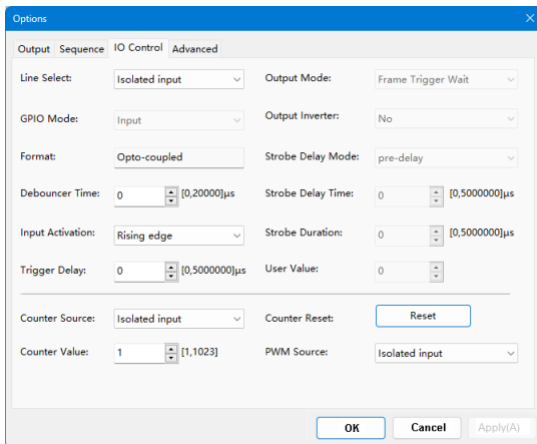

Figure 24 Options>IO Control page

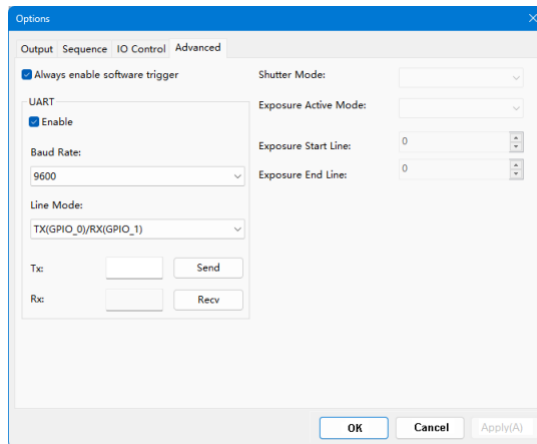

Figure 25 Options>Advanced page

The **Trigger Source** can be **Isolated input**, **GPIO0**, **GPIO1**(when configured as input), **Counter**, or **PWM** which can be configured on the **Options** property sheet. Also the camera's **Isolated output**, **GPIO0** or **GPIO1**(can be configured

as **Output**) can be used as **Output** or **UART** (**GPIO0**, **GPIO1** only) applications. All of these configurations can be realized on the **Options** property sheet described in Table 15 below.







About the captured file operation style, one can find it on the **Option>Output** page;

About the **Sequence** setup, one can find it on the **Option>Sequence** page;

About the camera pin **IO Control** style, one can find it on the **Options>IO Control** page;

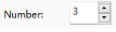
About the **Always enable software trigger** and **UART** setup, **Shutter Mode**, and **Exposure Active Mode**, one can find it on the **Options>Advance** page.

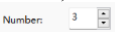
Table 15 Options property sheet for Trigger Source or camera pin configuration

Pages	Items	Descriptions
Output page	Output Destination	<p>Used to set the captured frame's Output destination, can be Show in the video window, Show in a new window or Save to disk;</p> <p>When Save to disk is checked, the  button will be enabled clicking it to choose the Base directory, clicking the Sub combo box's dropdown button to choose the Sub directory;</p> <p>The File Name Format, File Prefix, File Type, and even The sequence begin with can be chosen, set, or defined.</p> <p>Note:</p> <ol style="list-style-type: none"> 1)Valid only for Sequence or Multiple capture setup; 2)For Single or Loop capture, the captured image will be always displayed on the video window;
Sequence page	Type Disable Plan Hardware	<p>Disable: If the Disable button is chosen in the Type combo box on the Options>Sequence page, the Sequence button on the Capture & Resolution page will switch to Multiple button;</p> <p>Plan: 1)If Plan is chosen in the Type combo box on the Options>Sequence page, the Multiple button on the Capture & Resolution group will switch to Sequence button;</p> <p>2) If the Software Trigger Source is chosen in the Capture & Resolution group or the Always enable software trigger is checked on the Options>Advanced property page, the Sequence button will be enabled After the Software trigger signal is arrived(By clicking Single, Loop, or Sequence button), the camera will capture frames specified in the edit box with spin  Options... (we call it Frames Box) affiliated to the Sequence button; The whole captures will use the Exposure Time, Gain and Delay in the Sequence table list under  Number:  Preset one by one by the software;</p> <p>3) If the Disable button is chosen in the Type combo box on the Options>Sequence page, the Sequence button on the Capture & Resolution page will switch to Multiple button;</p> <p>4) The Sequence button will be enabled only when a) the Plan in the Type combo box is chosen on the Options>Sequence page and b) he Software Trigger Source is chosen in the Capture & Resolution group or c) Always enable software trigger is checked on the Options>Advanced property page;</p> <p>Hardware: 1) if Hardware is chosen in the Type combo box on the Options>Sequence page, the Multiple button on the Capture & Resolution group will switch to Sequence button and will be disabled for Hardware trigger. But users can still set the frames number in the Frame Box on the Capture & Resolution group;</p> <p>2) After the Hardware trigger signal arrives, the camera will capture frames specified in the edit box with spin  Options... (we call it Frame Box) affiliated to the Sequence button; The whole capture will use the Exposure Time, Gain (Delay is not used) in the Sequence table list under  Number:  Preset one by one but stored in the camera hardware for the quick operation;</p> <p>3) If the Disable button is chosen in the Type combo box on the Options>Sequence page, the Sequence button on the Capture & Resolution page will switch to Multiple button.</p> <p>4) The Sequence button is always disabled if a) The Hardware is chosen in the Type combo box on the Options>Sequence page and b)the Hardware Trigger Source is chosen in the Capture & Resolution group;</p> <p>5) The Sequence button will be enabled if a) the Software Trigger Source is chosen in the Capture & Resolution group or b) the Always enable software trigger checkbox is checked on the Options>Advanced property page, in this case, both the Plan and Hardware Sequence capture are supported;</p>
	Number	The possible Sequence (capture) frames to be captured. If the Number is larger than the Sequence Number in the Frames Box on the Capture & Resolution group, the other Indices will be executed at the next Sequence operation one by one recycled;
	Index	The order of the Number group;
	Exposure Time	The camera Exposure Time for the specified capture Index in the Sequence capture;
	Gain	The camera Gain for the specified capture Index in the Sequence capture;
	Delay	The Delay time for the specified capture Index in the Plan Sequence capture(Valid for Plan Sequence capture only);

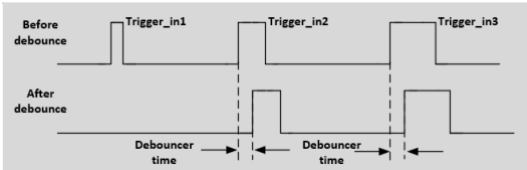
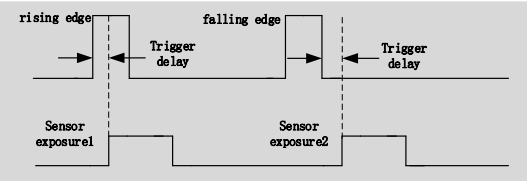
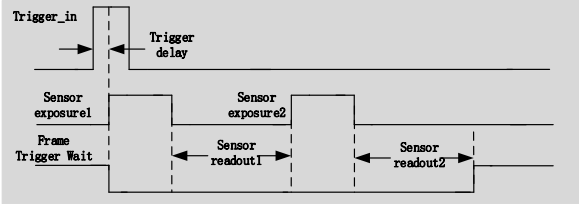
	Preset	<p>Choosing Save to save the current Sequence table's settings;</p> <p>Clicking Management to Rename the saved Sequence table's setting files or Remove them from the Management list;</p>
IO Control page	Line Select	Choosing which line to set. Can be Isolated input , Isolated output , GPIO0 or GPIO1 et al;
	GPIO Mode	<p>To configure whether the line selected in Line Select is for Input or Output. Only GPIO0 or GPIO1 can be configured as either Input or Output;</p> <p>If Isolated input or Isolated output is chosen, the GPIO Mode will be specified as Input or Output (Not configurable) respectively;</p>
	Format	Specify the current selected signal's Format in the Line Select combo box, can be Opto-coupled(Isolated input, Isolated output) or TTL (GPIO0 or GPIO1) for clarity(Unconfigurable);
	Debouncer Time	<p>Since there may be a glitch in the external trigger input signal if it directly enters into the internal logic circuit of the camera, it will cause false triggering, so the input trigger signal should be debounced. In addition, the effective pulse width of the trigger signal input by the user should be greater than the Debouncer Time, otherwise, the trigger signal will be ignored;</p> <p>When Isolated input, GPIO0 or GPIO1 is chosen in the Line Select combo box and GPIO0 or GPIO1 is configured as Input in the GPIO Mode combo box, the Debouncer Time will be enabled for the user to input the Debouncer Time between 0 to 20000us;</p> 
	Input Activation	<p>When Isolated input, GPIO0 or GPIO1 is chosen in the Line Select combo box and GPIO0 or GPIO1 is configured as Input in the GPIO Mode combo box; The Input Activation combo box will be enabled to configure the Input Activation as either Rising Edge or Falling Edge;</p> 
	Trigger Delay	<p>When Isolated input, GPIO0 or GPIO1 is chosen in the Line Select combo box and GPIO0 or GPIO1 is configured as Input in the GPIO Mode combo box, the Trigger Delay will be enabled for the user to input the Trigger Delay time between 0 to 5000000us;</p> <p>If the Trigger Delay time is set to 1000000us, the camera will wait for 1s to capture the image after receiving the trigger signal;</p>
	Output Mode	<p>When Isolated output, GPIO0 or GPIO1 is selected in the Line Select combo box and GPIO0 or GPIO1 is configured as Output in the GPIO Mode combo box, the Output Mode will be enabled. It can be Frame Trigger Wait, Exposure Active, Strobe, or User Output. The chosen mode can be used for diversified applications;</p> <p>The Frame Trigger Wait signal is pulled low at the start of exposure and pulled high when the last frame of data is read out. The trigger signal input by the user should be in the valid period. If the user inputs a trigger signal when the signal is low, the trigger signal input at this time will be ignored. The following example is the case when Burst Count = 2, as shown below;</p>  <p>ExposureActive: when this signal is high, it means the sensor is exposing. This signal can be used to control an external mobile device to remain stationary or move at low speed while the camera is at exposure. The timing diagram of the exposure valid signal is shown below;</p>

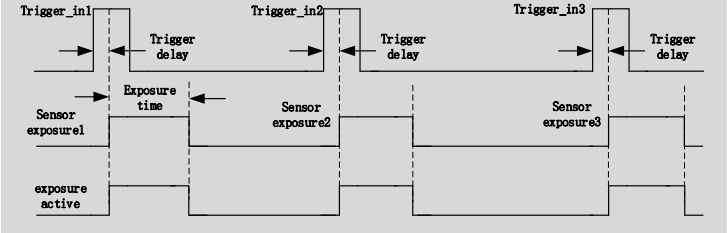
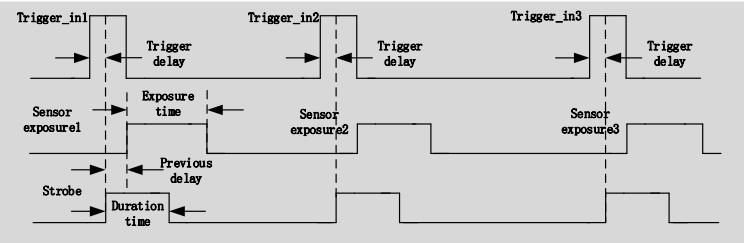
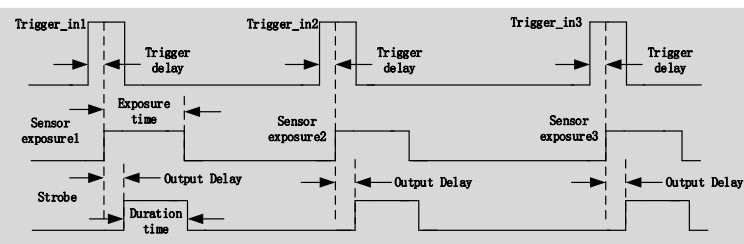
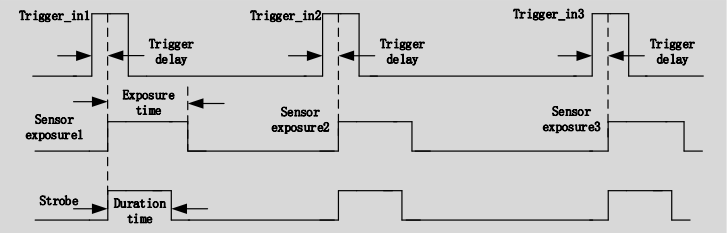
		 <p>When the relative position of the camera and the object to be photographed changes, you can refer to Exposure Active signal to prevent the captured image from being affected by movement and focus adjustment during the exposure process;</p> <p>When Strobe is chosen, Strobe Delay Mode, Strobe Delay Time, Strobe Duration will be enabled;</p> <p>When UserOutput is chosen, User Value will be enabled. lines3, line2, line1 are the combination of GPIO1, GPIO0 and Isolated output respectively. If User Value is 001, then line GPIO1 and GPIO0 will be disabled and Isolated output will be enabled;</p> <div style="text-align: center;"> <table border="1" data-bbox="836 630 1079 724"> <tr> <td></td> <td colspan="3" style="text-align: center;">LSB</td> </tr> <tr> <td>UserOutput Value:</td> <td style="text-align: center;">1</td> <td style="text-align: center;">0</td> <td style="text-align: center;">0</td> </tr> <tr> <td>Line:</td> <td style="text-align: center;">line3</td> <td style="text-align: center;">line2</td> <td style="text-align: center;">line1</td> </tr> </table> </div>		LSB			UserOutput Value:	1	0	0	Line:	line3	line2	line1
	LSB													
UserOutput Value:	1	0	0											
Line:	line3	line2	line1											
<p>Output Inverter</p>		<p>When Isolated output, GPIO0 or GPIO1 is selected in the Line Select combo box and Output is chosen for GPIO0 or GPIO1 in the GPIO Mode combo box, the Output Inverter will be enabled to configure the current selected line's output as either inverted or not(Yes or No).</p>												
<p>Strobe Delay Mode</p>	<p>Delay</p>	<p>Strobe can be used to control external devices such as the strobe, and the effective level duration, delay time, and pre-delay time of the strobe signal can be set;</p> <p>When the Output Mode is Strobe, Strobe Delay Mode will be enabled. It can be pre-delay or delay;</p>												
<p>Strobe Delay Time</p>	<p>Delay</p>	<p>When exposure starts, the strobe does not take effect immediately, and the output is delayed according to the value set by Strobe Delay Time which is between 0 to 5000000us. The Strobe Delay Mode can be pre-delay or delay; It is described below;</p> <p>pre-delay:</p>  <p>delay:</p> 												
<p>Strobe Duration</p>		<p>The high level duration of the strobe is determined by the Strobe Duration which is between 0 to 5000000us as shown below;</p> 												
<p>User Value</p>		<p>Users can input a value at User Value edit box with spin to control the line as disable or enable. Enabled when User Output is chosen in the Output Mode combo box. The logical value 0 or 1's combination of GPIO1(line3),</p>												

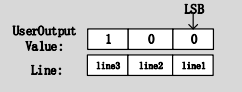
		<p>GPIO0(line2) and Isolated output(line1);</p> <p>When the output mode is selected as User Output, the user can input a value at User Value edit box to control the corresponding line output with 0 or 1;</p> <p>The value here is only valid for the lower three bits of a binary. For example, when line 1 and line 3 are set to User Output mode, and its User Value is set to 4 ('b100), then line 3 outputs 1, and line 1 outputs 0, as shown below.</p> 
	Counter Source	When Counter is chosen in the Trigger Source combo box in the Capture & Resolution group, the Counter Source can be chosen from Isolated input , GPIO0 or GPIO1 in this combo box on the Option>IO Control page;
	Counter Value	The Counter Value is used to divide the frequency of the external input trigger signal when the Counter Trigger Source is chosen in the Capture & Resolution group; See Counter in Table 14 for detail;
	Counter Reset	Click Reset button can clear the current counting process and begin a new one;
	PWM Source	When PWM is chosen in the Trigger Source combo box in the Capture & Resolution group, the PWM Source can be from Isolated input , GPIO0 , or GPIO1 in this combo box et al. ;
Advanced page	Always enable software trigger	<p>When this button is checked, no matter whether Trigger Source is Software or Hardware, the software trigger buttons(Single, Loop, Multiple) are always enabled;</p> <p>If the Plan or Hardware is chosen in the Type combo box on the Options>Sequence page, the Multiple button will switch to Sequence button; The Sequence button will be enabled if a)the Software Trigger Source is chosen in the Capture & Resolution group or b) the Always enable software trigger checkbox is checked on the Options>Advanced property page, in this case, both the Plan and Hardware Sequence captures are supported;</p>
	UART	<p>There is a serial port function on the Advanced page, which can be used to communicate with external devices via serial port. Check Enable to enable this function. When enabled, GPIO0 and GPIO1 can only be used as UART transfers;</p> <p>The Baud Rate supports 9600-115200. Cable Select can configure GPIO0 and GPIO1, which can be configured as TX or RX respectively. Setting a value at TX, clicking Send to send the set value out; click Accept at RX to receive the value from the external device;</p>
	Shutter Mode	Enabled if the camera supports. Users can select Rolling Shutter or Global Reset ;
	Exposure Active Mode	Enabled if the camera supports. Users can select Specified lines or Common exposure time ;
	Exposure Start Line	Enabled when Specified lines in the Exposure Active Mode combo box is selected. To configure when the Exposure Active signal is valid;
	Exposure End Line	Enabled when Specified lines in the Exposure Active Mode combo box is selected. To configure when the Exposure Active signal is invalid;

6.2 Application installation

In terms of software, customers are welcome to visit our website: <https://toupTek.com/download/> to download the latest ToupView. SWIR series can also be used with ASCOM, DirectShow interface. If the third-party software is compatible with these interfaces, customers can also download software drivers from our website and install them into the third-party software.

6.3 Introduction to ToupView

ToupView is a professional software that integrates camera control, image acquisition and processing, image browsing and analysis functions. ToupView has the following characteristics:

- x86: XP SP3 and above ; CPU supports SSE2 and above
- x64: Win7 and above
- Support video mode and Trigger Mode (Raw format or RGB format)
- Automatic capture and quick recording capabilities
- Supports multiple languages
- Hardware ROI and digital binning capabilities
- Rich image processing functions, such as image stitching, real-time overlay, flat field correction, dark field correction, etc.
- Supports all ToupTek cameras

6.3.1 User interface design

- The menus and toolbars are properly set to ensure quick operation
- Professionally integrated with 5 sidebars - Camera, Folders, Undo/Redo, Layers, Measure
- Comfortable operation method (double-click or right-click context menu)
- Detailed help manual

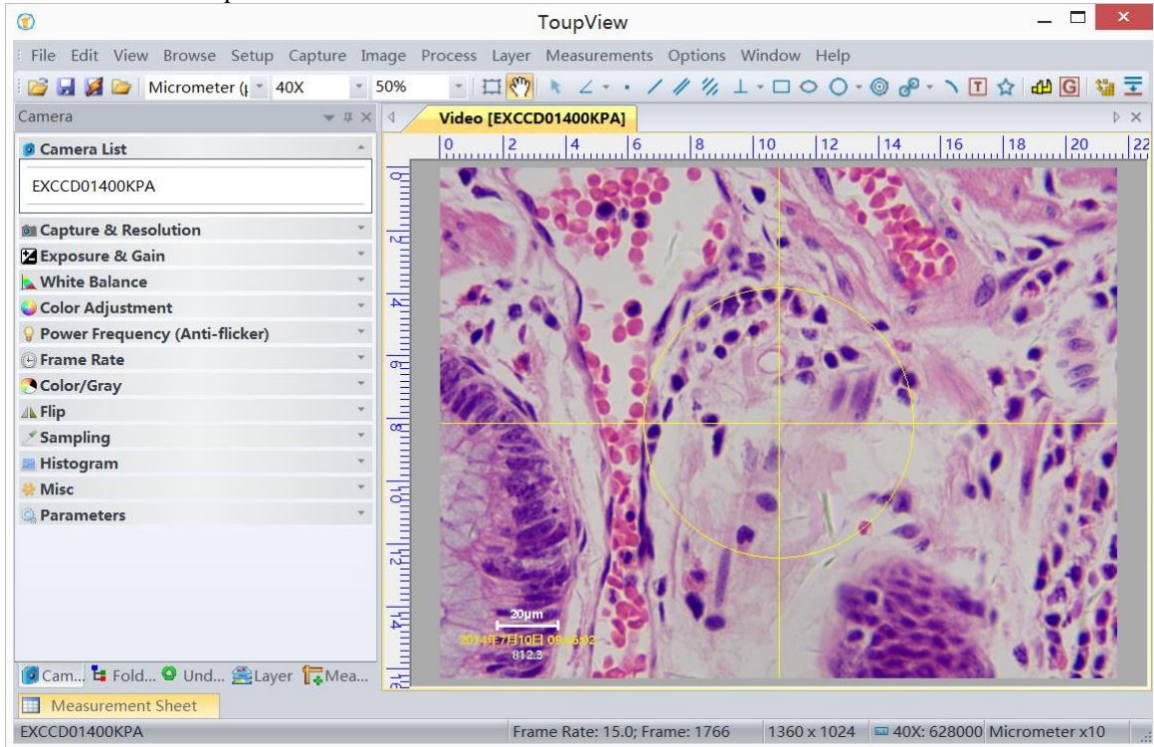

Figure 26 ToupView video window

6.3.2 Professional Camera Control Sidebar

Capture & Resolution	Set up live and still capture, snap images, or record video
Exposure & Gain	Auto exposure (preset exposure target value), manual exposure (exposure time can be manually entered and set by slider); gain up to 5 times
White Balance	Advanced one-click smart white balance settings, and you can adjust white balance by manually setting color temperature and color
Color Adjustment	Color, saturation, brightness, contrast, gamma initial high-speed adjustment function
Frame Rate Control	For different computer and USB performance, the camera can be super compatible by adjusting the frame rate
Flip	Select "Horizontal" or "Vertical" to adjust the sample orientation to ensure the same orientation as the visual system
Sampling	Neighborhood averaging can improve the signal-to-noise ratio of the video stream; while the sampling extraction mode can ensure the sharpness of the video stream. Supports histogram expansion of video stream, image negative and positive switching, grayscale calibration, and sharpness factor calculation to facilitate video focusing
Bit Depth	8, 12-bit switching, 8-bit is the basic Windows image format. 12-bit has higher image quality but reduces frame rate
Roi	ROI, Region of interest. This function can set the ROI value of the video window. After the ROI group is expanded, a rectangular box will appear in the middle of the video window, and the ROI can be changed. The mouse can adjust the size of the ROI. If there is no problem with the ROI, click "Apply" to set the video to the size of the ROI, and the default value will be restored to the original size.
Dark Field Correction	To enable darkfield correction, you should first capture a field image, then click Enable. Check Enable to enable darkfield correction. Uncheck it to disable darkfield correction
Cooling	Set TEC Target Temperature, fan on/off

Parameter Save	Load, save, overwrite, load, export custom camera panel controls (including calibration information, exposure parameters and color settings information, etc.)
----------------	--

6.3.3 Professional and practical image processing functions

Video Function	Various video professional processing functions: video broadcasting, timing capture, video recording, video watermarking, watermark mobile alignment, watermark rotation alignment, video grid overlay, video measurement, video scaling, gray scale calibration, video high dynamic (HDR), video depth of field extension, video image stitching, video scale, date, etc.
Image Processing and Enhancement	Image contrast control and adjustment, image denoising, various image filtering algorithms, image mathematical morphology algorithms, image rotation, image scaling and image printing, etc.
Image Overlay	The ToupView image overlay denoising function introduces advanced image matching technology. Users only need to record a short video of the image to be superimposed, and they can superimpose and output high fidelity in the case of displacement, rotation and magnification change between multiple frames of the video. images, easy to use

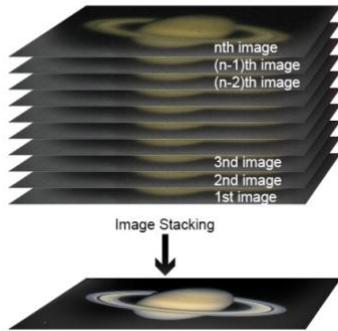

Figure 27 Image overlay denoising

6.3.4 Super compatibility

Camera Video Interface	Provide Twain, DirectShow, Labview, SDK installation package (native C++, C#)
Supported Operating Systems	Compatible with Microsoft® Windows® XP / Vista / 7 / 8 /10 /11(32 & 64 bit), Mac OSX, Linux
Language Support	Language support can be added manually, currently supports English, Simplified Chinese, Traditional Chinese, German, Japanese, Russian, French, Italian, Polish, Turkish

6.3.5 Basic hardware requirements

PC Basic Configuration Requirements	CPU: Intel Core 2 2.8GHz or higher
	RAM: 2GB or more
	USB Port: USB3.0 / USB 2.0
	Monitor: 17" or higher
	CD-ROM

6.4 Software development instructions

6.4.1 SDK description

The download link of the SDK is as follows:

<http://www.touptek.com/download/showdownload.php?lang=en&id=32>

6.4.2 SDK support platform

- Win32:
 - x86: XP SP3 and above; the CPU needs to support at least the SSE2 instruction set.
 - x64: Win7 and above.
 - arm: Win10 and above.
 - arm64: Win10 and above.

- WinRT: x86, x64, arm, arm64; Windows 10 and above.
- macOS: x86 and x64 bundle; macOS 10.10 and above.
- Linux: core 2.6.27 and above.
x86: The CPU needs to support at least the SSE3 instruction set; GLIBC 2.8 and above.
x64: GLIBC 2.14 and above.
armel: GLIBC 2.17 and above; compiled by toolchain arm-linux-gnueabi (version 4.9.2).
armhf: GLIBC 2.17 and above; compiled by toolchain arm-linux-gnueabi (version 4.9.2).
arm64: GLIBC 2.17 and above; compiled by toolchain aarch64-linux-gnu (version 4.9.2).
- Android: arm, arm64, x86, x64; compiled by android-ndk-r18b.

6.4.3 Introduction to SDK content

ToupCam series cameras support a variety of APIs, including: Native C/C++, .NET/C#/VB.NET, Python, Java, DirectShow, Twain, LabView, Matlab, etc. Compared with other APIs, Native C/C++ API as a low-level API is characterized by using pure C/C++ development without relying on other runtime libraries. The interface is simple and the control is flexible. This SDK zip package contains all the resources and information needed. The directory is as follows:

- inc:
toupcam.h, the C/C++ header file.
- win: Microsoft Windows platform file
 - ◆ dotnet:
toupcam.cs, supports C#. toupcam.cs uses P/Invoke to call toupcam.dll. Please copy toupcam.cs to your C# project for use.
toupcam.vb, supports VB.NET. toupcam.vb uses P/Invoke to call toupcam.dll. Please copy toupcam.vb to your VB.NET project for use.
 - ◆ x86:
toupcam.lib, x86 lib file.
toupcam.dll, x86 dynamic library file.
democpp.exe, x86 C++ demo execute the procedure.
- x64:
toupcam.lib, x64 lib file.
toupcam.dll, x64 dynamic library file.
democpp.exe, x64 C++ demo execute the procedure.
- arm:
toupcam.lib, arm lib file.
toupcam.dll, arm dynamic library file.
- arm64:
toupcam.lib, arm64 lib file.
toupcam.dll, arm64 dynamic library file.
- winrt:
They can be applied for Dynamic library files of WinRT/ UWP (Universal Windows Platform)/ Windows Store App. They are compatible with Windows Runtime and can be referenced by Universal Windows Platform apps. If you use C# to develop UWP, you can use the toupcam.cs wrapper class.
Please pay attention to the Device Capability of uwp. Refer to how to add USB device capabilities to the

app manifest. (Microsoft seems to limit the Device entry under DeviceCapability to no more than 100) demouwp.zip is a simple example of uwp. Please modify vid and pid. under DeviceCapability in the file Package.appxmanifest before compiling the run example.

- Drivers: (Cameras produced after 2017.1.1 support WinUSB, and drivers no longer need to be installed on Windows 8 and above)

The x86 folder contains the x86 kernel-mode driver files, including toupcam.cat, toupcam.inf and toupcam.sys.

The x64 folder contains the x64 kernel-mode driver files, including toupcam.cat, toupcam.inf and toupcam.sys.
- samples:
 1. democpp, C++ example. This example demonstrates enumerating devices, opening devices, previewing videos, capturing images, setting resolution, triggering, saving images to files in various image formats (.bmp, .jpg, .png, etc.), wmv format video recording, Trigger Mode, IO control and so on. This example uses the Pull Mode mechanism. To keep the code clean, the WTL library used by the examples can be downloaded from this link <http://sourceforge.net/projects/wtl/>.
 2. demopush, C++ example, using the Push Mode mechanism, StartPushModeV3.
 3. demomfc, a simple C++ example, uses MFC as a GUI library, supports opening devices, previewing videos, capturing images, setting resolution, saving images to files in various image formats (.bmp, .jpg, .png, etc.), etc. This example uses the Pull Mode mechanism.
 4. demowinforms1, take C# winform for example, it supports opening devices, previewing videos, capturing images, saving images to files, and setting white balance. This example uses the Pull Mode mechanism, StartPullModeWithWndMsg.
 5. demowinforms2, take C# winform for example, it supports opening devices, previewing videos, capturing images, saving images to files, and setting white balance. This example uses the Pull Mode mechanism, StartPullModeWithCallback.
 6. demowinforms3, take C# winform for example, it supports opening devices, previewing videos, capturing images, saving images to files, and setting white balance. This example uses the Push Mode mechanism, StartPushMode.
 7. demowinformvb, take VB.NET winform for example, it supports opening devices, previewing videos, capturing images, saving images to files, and setting white balance. This example uses the Pull Mode mechanism.
- linux: Linux platform files

Udev: 99-toupcam.rules, udev rule file.

Please refer to: http://reactivated.net/writing_udev_rules.html.
- c#: toupcam.cs, Support. Net Core C#. toupcam.cs uses P/Invoke to call libtoupcam.so. Please copy toupcam.cs to your C# project for use.
- x86: libtoupcam.so, x86 version so file.
- x64: libtoupcam.so, x64 version so file.
- armel: libtoupcam.so, armel version so file, toolchain is arm-linux-gnueabi.
- armhf: libtoupcam.so, armhf version so file, toolchain is arm-linux-gnueabi.
- arm64: libtoupcam.so, arm64 version so file, toolchain is aarch64-linux-gnu.
- android: libtoupcam.so for four architectures of Android platform arm, arm64, x86, x64.
- mac: macOS platform files.
- python: toupcam.py and example code.
- java: toupcam.java and example code (console and Swing).
- doc: SDK usage documentation, Simplified Chinese, English.
- sample:

- de emosimplest, the simplest example, is about 60 lines of code.
- demoraw, RAW data and still shots, about 120 lines of code.

6.4.4 Third-party interface software

- directshow: DirectShow SDK and demo program.
- twain: TWAIN SDK.
- labview: Labview SDK and demo program.
- matlab: MatLab demo program.
- Micromanager.

7 sMAX04BM-CL100 Camera application

7.1 Connection to the CameraLink

Connect the two CameraLink cables: the SDR1 port on the camera is connected to the CL1 port on the capture card, the SDR2 port on the camera is connected to the CL2 port on the capture card.

Attention: if the camera and the acquisition card cross-linking, camera will not work. Please pay special attention.

7.2 Software installation

7.2.1 Install SDK

Windows 10 system can directly select the exe shown in Figure 28 to install SDK; For Windows 7, please install the driver shown in Figure 29.

名称	修改日期	类型	大小
SaperaLTSDKSetup_8.60.exe	2023/4/28 13:49	应用程序	413,617 KB
Xtium2-CL MX4.pdf	2023/4/28 13:59	Microsoft Edge ...	4,426 KB
xtium-cl_mx4_130000311.exe	2023/4/28 13:49	应用程序	43,574 KB

Figure 28

SaperaLTSDKSetup_8.60.exe	2023/4/28 13:49	应用程序	413,617 KB
Windows6.1-KB3033929-x64.msu	2023/8/24 10:37	Microsoft 更新独...	44,843 KB
Xtium2-CL MX4.pdf	2023/4/28 13:59	Microsoft Edge ...	4,426 KB
xtium-cl_mx4_130000311.exe	2023/4/28 13:49	应用程序	43,574 KB

Figure 29

7.2.2 Install options

The following is the interface to be selected, and the rest of the steps can be directly clicked next.

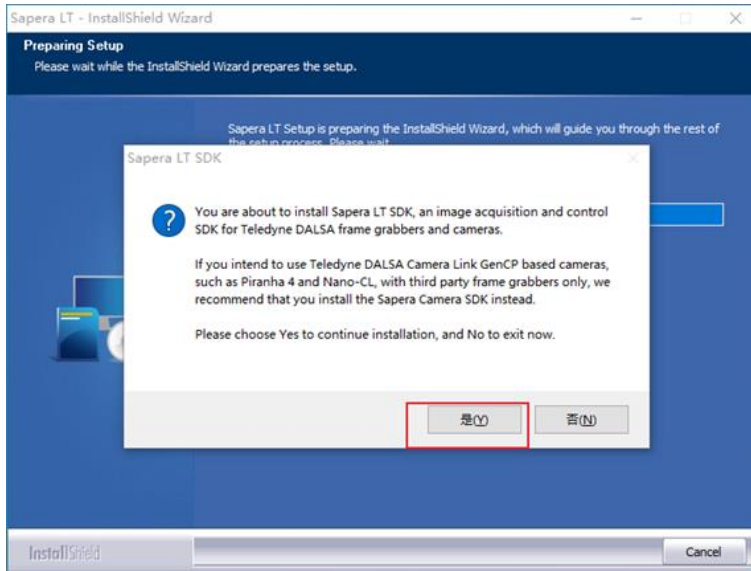

Figure 30

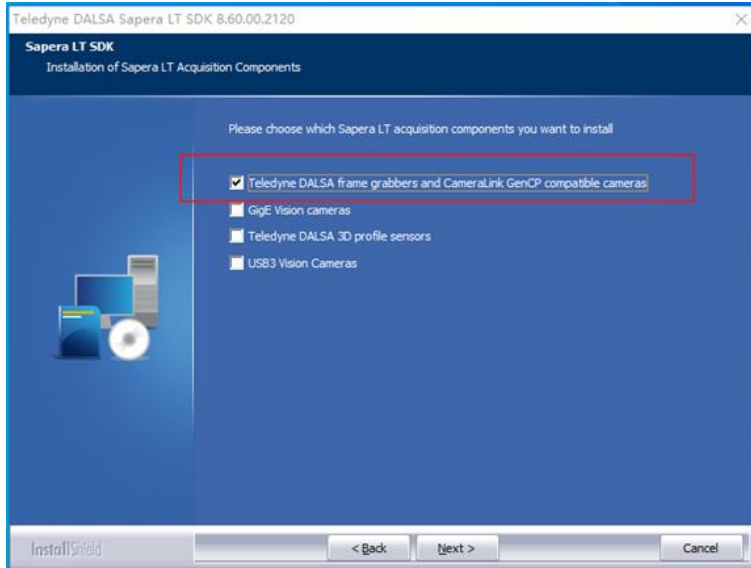

Figure 31

7.2.3 Install the driver

The exe shown in Figure 32 is the driver of the capture card (xtium-cl_mx4) currently used by our company, and the drivers of dalsa acquisition cards are different.

Capture card driver installation steps can be all click Next.

SaperaLTSDKSetup_8.60.exe	2023/4/28 13:49	应用程序	413,617 KB
Xtium2-CL MX4.pdf	2023/4/28 13:59	Microsoft Edge ...	4,426 KB
xtium-cl_mx4_130000311.exe	2023/4/28 13:49	应用程序	43,574 KB

Figure 32

Restart your computer after the installation is complete.

7.3 Configure the Dalsa capture card

7.3.1 Serial port configuration

Find the software Sapera Configuration in Figure 33 of the DALSA supporting tool, open it, change COM port mapping (optional) to the required port (currently COM2) as shown in Figure 34, and restart the computer according to the program requirements.

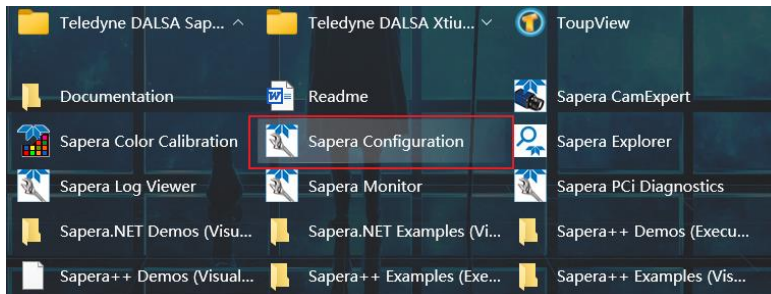

Figure 33

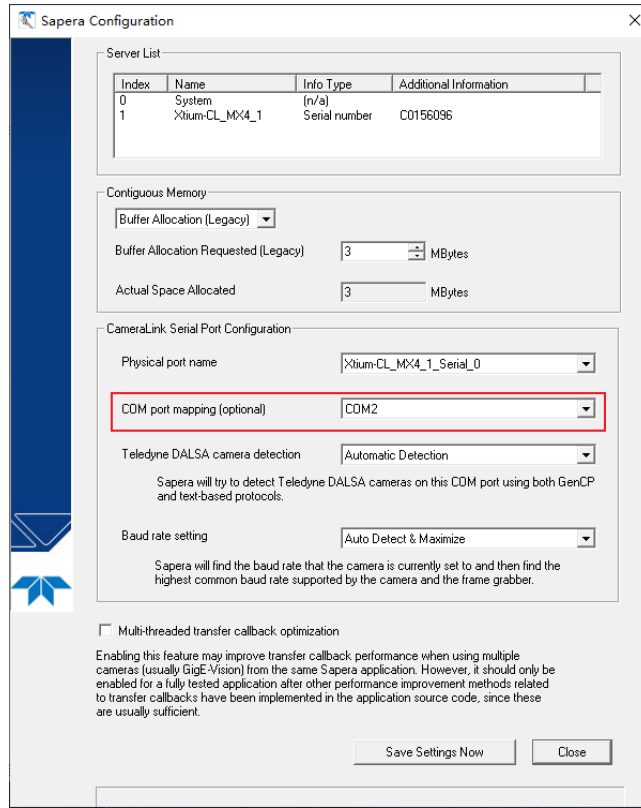

Figure 34 Serial port configuration dialog box

7.3.2 CameraLink mode configured

Open the software in Figure 35 and verify that it looks like Figure 36. If not, please click the Manual button in Figure 20 to modify the tart as shown in Figure 37, and click the tart Updat button to wait for the completion of the update. If an error occurs, please confirm whether the serial port control is turned off.

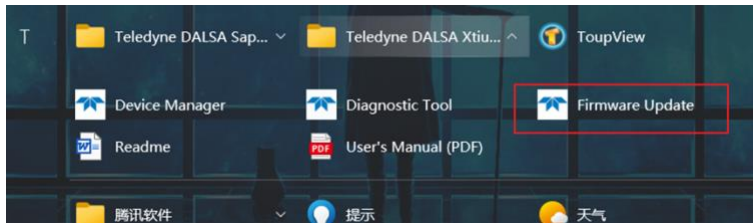

Figure 35

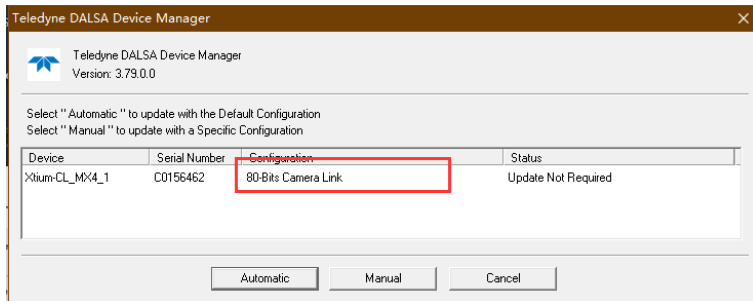

Figure 36

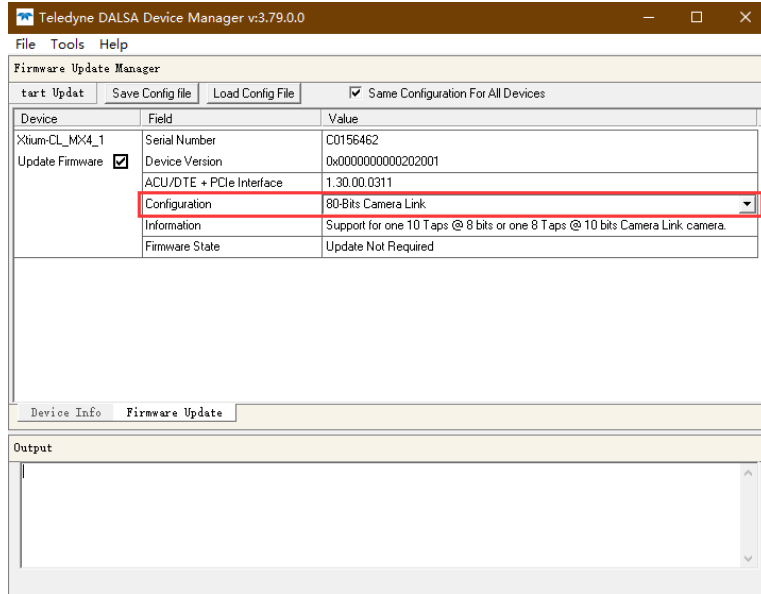

Figure 37

7.3.3 Configuring CameraLink Receiving

Opening the Spera CamExpert software of DALSA, click the arrow position in Figure 38 and select sMAX04BM_CL_10bit_8Ports_V1.0.ccf to load the configuration information of the receiving format of CameraLink.

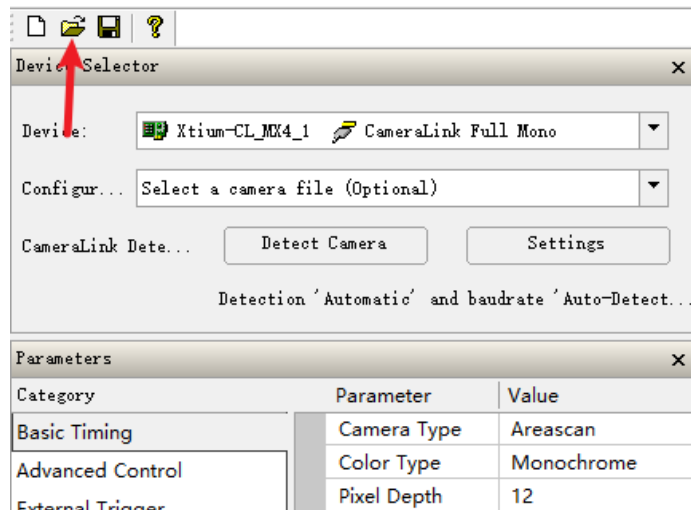

Figure 38 Load the CameraLink receive format configuration information

The arrangement is shown in Figure 39(You do not need to change the arrangement of the ccf files mentioned above).

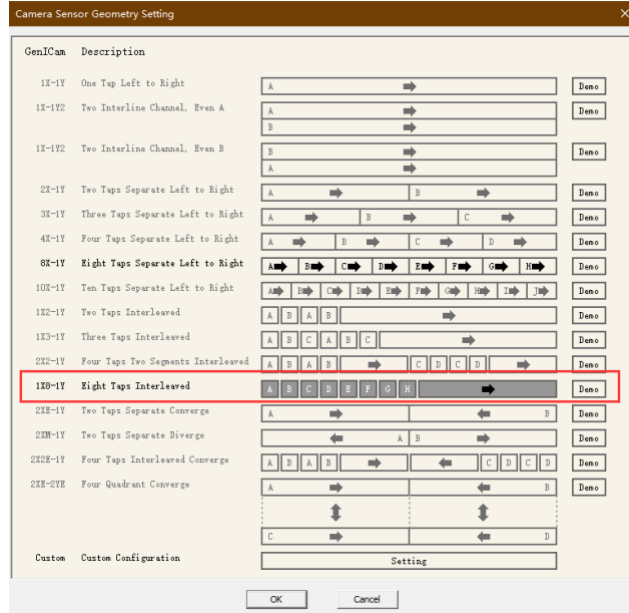

Figure 39 Arrangement

7.3.4 CameraLink Receiving the configuration content

The image below shows the resolution and bit depth Settings.

Parameter	Value
Camera Type	Areascan
Color Type	Monochrome
Horizontal Activ...	2048
Horizontal Offs...	0
Vertical Active (...)	2048
Vertical Offset (...)	0
Pixel Clock Inp...	85
Camera Sensor...	1X8-1Y
PoCL	Disabled
PoCL Status	Not Active

Figure 40

The steps of Camera Sensor Geometry Setting are shown in Figure 41 and Figure 42.

Parameter	Value
Camera Type	Areascan
Color Type	Monochrome
Horizontal Activ...	2048
Horizontal Offs...	0
Vertical Active (...)	2048
Vertical Offset (...)	0
Pixel Clock Inp...	85
Camera Sensor...	1X8-1Y
PoCL	Disabled
PoCL Status	Not Active

Figure 41

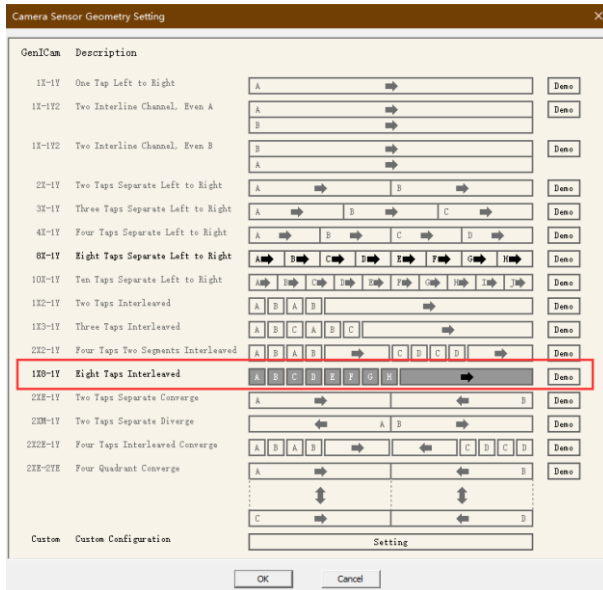

Figure 42

7.4 Using GenIcam

7.4.1 Communication Settings

Enter the interface shown in Figure 43 and set the content as shown in Figure 44.

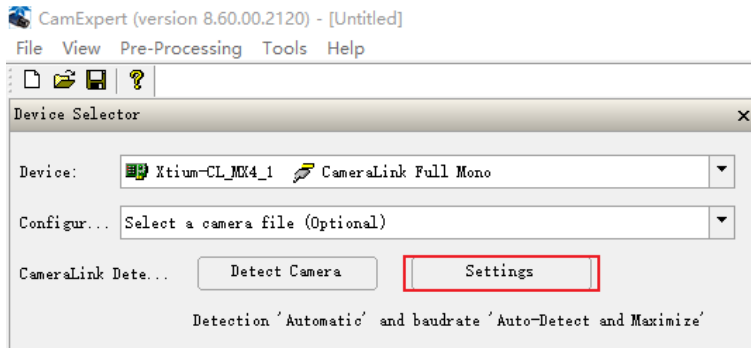

Figure 43

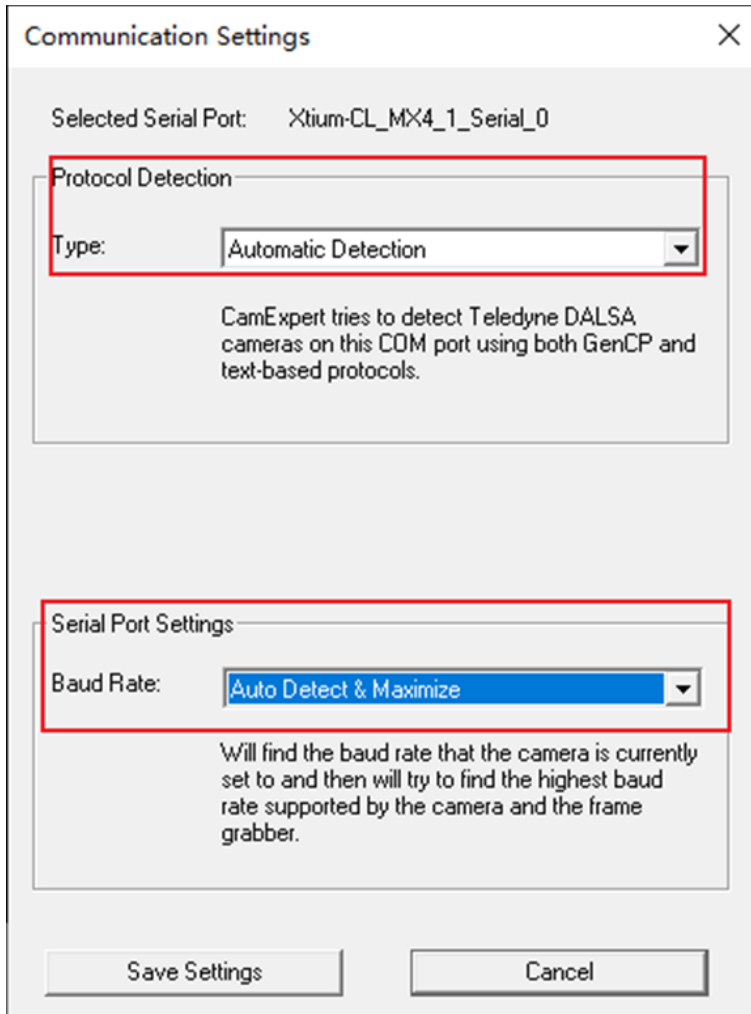

Figure 44

After the Settings are complete, properly connect the camera and restart CamExpert. Figure 45 will appear on the software interface.

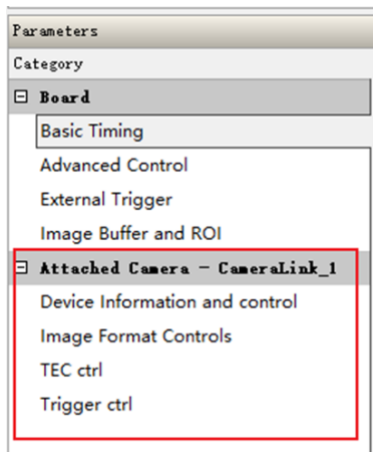

Figure 45

7.5 Description of GenIcam

7.5.1 Device Information and control

As shown in Figure 46, it contains the basic information of the equipment, including exposure time control, gain control, frame rate control and TEC temperature display.

Category	Parameter	Value
Board	Manufacturer ...	touptek hangzh
Basic Timing	Device Family	toupswir
Advanced Control	Model Name	toupswir331k
External Trigger	Serial Number	...
Image Buffer and ROI	expo time	100
	gain	Middle Gain
Attached Camera - ...	Frame Frequency	700
Device Information and ...	Deniose mode ...	Enable
Image Format Controls	Deniose level	5
TEC ctrl	TEC_temp	0.4
Trigger ctrl	Show More >>	

Figure 46

7.5.2 Image Format Controls

Figure 47 shows the ROI control.

Parameters		
Category	Parameter	Value
Board	Horizontal Offset	0
Basic Timing	Vertical Offset	0
Advanced Control	Width	640
External Trigger	Height	512
Image Buffer and ROI	Show More >>	
Attached Camera - CameraLink_1		
Device Information and control		
Image Format Controls		
TEC ctrl		
Trigger ctrl		

Figure 47

7.5.3 TEC Ctrl

As shown in Figure 48, TEC Ctrl contains TEC temperature control, TEC switch, fan switch, and TEC temperature display in degrees Celsius.

Category	Parameter	Value
Board Basic Timing Advanced Control External Trigger Image Buffer and ROI	set temp	0.0
	TEC mode select	Enable
	Fan mode select	Enable
	TEC_temp	-1.5
Show More >>		
Attached Camera - ... Device Information and ... Image Format Controls TEC ctrl Trigger ctrl		

Figure 48

7.5.4 Trigger ctrl

The trigger control content Settings are shown in Figure 49 and contain the basic trigger Settings.

Parameters		
Category	Parameter	Value
Board Basic Timing Advanced Control External Trigger Image Buffer and ROI	Tri mode	Disable
	Softalways	Disable
	TriSource	Opt_in
	TriActivation	rising edge
	Burst Counter	0
Attached Camera - ... Device Information and ... Image Format Controls TEC ctrl Trigger ctrl	CounterSource	Opt_in
	Counter Value	0
	PWMSource	Opt_in
	Soft trigger	Disable
	Triggger Delay0	0
	Triggger Delays	0
	Output Mode0	0
	DurationTime	0
	PreDelay	0
	OutputDelay	0
	UserValue	Opt_in
	TriProhibited	4100
	Counter Reset	Disable
	Debounce0	0
	Line Inverter	-Invalid value-
OutputCounter	1	

Figure 49

7.6 Camera Commands

7.6.1 Basic Formats

The serial port of the camera CameraLink is used as the communication port. The baud rate of the serial port is 115200, and the serial port has 8 bits without check bit mode.

The protocol format is compatible with GENICAM genepc 1.0. For details, refer to GENICAM protocol.

The protocol instruction is realized by register access, each function is distinguished and defined by different register addresses, and the protocol data is divided into general part and special part. The protocol data is preceded by the general part and followed by the special part. The general part is fixed to the length of 16 bytes, and the length of the special part is variable according to the different length of the function.

The general 16-byte format is described as follows (all fields in the general part are in Big-Endian format with high bytes before them) :

Suppose the sixteen bytes of data are D0, D1, D2, D3, D4, D5, D6, D7, D8, D9, D10, D11, D12, D13, D14, D15. For command execution, the protocol stipulates that the host computer is the active initiator and the device is the passive responder.

1. D0, D1 is two prefix bytes, fixed as 0x01 and 0x00.
2. D2 and D3 are the check words of the universal partial data. The check part ranges from D6, D7 to D14, and D15 adopts double-byte CRC redundancy check, with the high byte coming first (Big-Endian).
3. D4 and D5 are the check words for the total protocol data. The check part runs from D6 and D7 to the end of the entire protocol data. Double-byte CRC redundancy check is also adopted, with the high byte in the front (Big-Endian).
4. D6 and D7 are channel ids. At present, the device channel is fixed to 0, and the data is 0x00 and 0x00.
5. D8 and D9 are common flag fields. For the upper computer, if the value is 0x40, 0x01 indicates that the normal function request is sent and the device needs to respond. If the value is 0x00, 0x01 indicates that the normal function request is sent and the device does not need to respond. For the response of the device, the field is 0x00. 0x00 indicates that the device receives the response correctly and there is no exception.
6. D10 and D11 are command ids, which are general command definition fields. For the upper computer, the values are 0x08 and 0x00 when reading data and 0x08 and 0x02 when writing data. For the device, the value is 0x08, 0x01 when it responds to read data, 0x08, 0x03 when it responds to write data.
7. D12, D13 indicates the length of the dedicated part data.
8. D14 and D15 are sequence ids. For the upper computer, the sequence ID needs to be increased by one for each command sent. The sequence ID remains the same for a device-side response to ensure that the host machine receives confirmation that the device-side instruction is executed correctly.

7.6.2 Dedicated Part Format

For the special part of the format is mainly divided into two read and write registers (register and length field is fixed in the Big-Endian format before the high byte, the rest of the data can be Big-Endian or Little-Endian, according to the custom)

1. Format description of the special part when the upper computer reads the register data

The whole dedicated data length is 12 bytes, if the data is R0, R1, R2, R3, R4, R5, R6, R7, X0, X1, X2, X3, where R0~R7 is the register address that needs to be read; X0, X1 is fixed to 0x00, 0x00; X2, X3 are the length of the data to be read (the length is the legal length defined by the register, and the length of each register is specified).

2. Format description of the special part when the device responds to the upper computer reading register data

The whole private data is the data that needs to be read, there are no other fields; The length varies according to the length of the data read, such as X1, X2, X3..... Xn; The length of the read data is n.

3. Format description of the special part of the upper computer when writing register data

When the upper computer writes register data, the special part of the data consists of two parts: register and data, such as R0, R1, R2, R3, R4, R5, R6, R7, X1, X2, X3..... Xn; R0 to R7 indicates the register address (REG_ADDR). X1 to Xn indicates the data to be written. The length of the data to be written is n, which is the legal length specified by the register.

4. Format description of the special part when the device responds to the host computer to write register data

When the device successfully writes data from the host computer, the dedicated data part of the device response is fixed as 0x00, 0x00, 0x00, 0x00.

7.6.3 Definition of each register

ADDR_BASE = 0x0000000020000000

REG_ADDR = ADDR_BASE + ADDR_OFFSET

Number	Register function	Register address (ADDR_OFFSET)	Register value	default parameters	data length	R/W	Data sequence
1	ROI columns	0x070	0-2047	0	4byte	RW	little
2	ROI column starting position	0x080	0-2047	2048	4byte	RW	little
3	ROI rows	0x090	0-2047	0	4byte	RW	little
4	ROI row starting position	0x0A0	0-2047	2048	4byte	RW	little
5	Exposure	0x200	16~100000(us)	100	4byte	RW	Big
6	Gain	0x230	1~700	700	4byte	RW	Big
7	Frame rate control	0x280	1~10	5	4byte	RW	Big
8	Denoising level	0x330	T (°C) = data/10, 二进制补码	0	4byte	RW	Big
9	Algorithm control	0x340	T (°C) = data/10, 二进制补码		4byte	R	Big
10	Defective pixel reload	0x350	1 为开, 0 为关	1	4byte	RW	Big
11	TEC Temperature Setting	0x360	1 为开, 0 为关	1	4byte	RW	Big
12	TEC temperature reading	0x390	1 为开, 0 为关 (暂不支持)	0	4byte	RW	Big
13	TEC switch control	0x400	0-Normal Mode 1-Trigger Mode	0	4byte	RW	Big
14	Fan control	0x410	0-soft disable 1-soft always enable	0	4byte	RW	Big
15	Automatic dark field switch	0x420	trigger source: 0-Opt_in 1-GPIO_0 2-GPIO_1 3-counter 4-PWM 5-software	0	4byte	RW	Big
16	Manual dark field selection	0x430	0-rising edge; 1-falling edge; 2-level high; 3-level low	0	4byte	RW	Big
17	Auto exposure switch	0x440	continuous acquisition 0-65535	0	4byte	RW	Big
18	tri_mode	0x450	0-Opt_in 1-GPIO_0 2-GPIO_0	0	4byte	RW	Big
19	soft always en	0x460	Frequency division	0	4byte	RW	Big

			coefficient				
20	tri_source_i	0x470	0-Opt_in 1-GPIO_0 2-GPIO_1	0	4byte	RW	Big
21	tri_activation_i	0x430	0bit: GPIO_0: 0-input,1-output 1bit: GPIO_1: 0-input,1-output	0	4byte	RW	Big
22	burst_counter_i	0x440	software trigger	0	4byte	W	Big
23	counter_source_i	0x450	when the Opt_in trigger assert, the start of exposure will delay 0-32xffff_ffff (cycle)	0	4byte	RW	Big
24	counter_value_i	0x460	when the GPIO_0 trigger assert, the start of exposure will delay 0-32xffff_ffff (cycle)	0	4byte	RW	Big
25	pwm_source_i	0x470	when the GPIO_1 trigger assert, the start of exposure will delay 0-32xffff_ffff (cycle)	0	4byte	RW	Big
26	IO_link	0x480	when the software trigger assert, the start of exposure will delay 0-32xffff_ffff (cycle)	0	4byte	RW	Big
27	soft_start	0x490	Opt_out output mode: 0-Frame Trigger Wait 1-Exposure Active 2-Strobe 3-User output	0	4byte	RW	Big
28	tri_delay_0_i	0x4a0	GPIO_0 Output mode: 0-Frame Trigger Wait 1-Exposure Active 2-Strobe 3-User output	0	4byte	RW	Big
29	tri_delay_1_i	0x4b0	GPIO_1 output mode: 0-Frame Trigger Wait 1-Exposure Active 2-Strobe 3-User output	0	4byte	RW	Big
30	tri_delay_2_i	0x4c0	Strobe duration time:effective time 0-32xffff_ffff (cycle)	0	4byte	RW	Big
31	tri_delay_s_i	0x4d0	advance the exposure time 0-32xffff_ffff (cycle)	0	4byte	RW	Big
32	output_mode_0_i	0x4e0	later than exposure time 0-32xffff_ffff (cycle)	0	4byte	RW	Big
33	output_mode_1_i	0x4f0	Opt_out--user value	0	4byte	RW	Big
34	output_mode_2_i	0x500	next trigger rising prohibited time 4100~32xffff_ffff (cycle)	4100	4byte	RW	Big
35	duration_time_i	0x510	When counter_reset assert, the counter of trigger will be reseted	0	4byte	W	Big
36	pre_delay_i	0x520	debounce time: 0-20000us	0	4byte	RW	Big
37	output_delay_i	0x530	debounce time: 0-20000us	0	4byte	RW	Big

38	user_value	0x540	debounce time: 0-20000us	0	4byte	RW	Big
39	tri_prohibited_i	0x550	1-enable	3'b111	4byte	RW	Big
40	counter_reset	0x560		1	4byte	RW	Big
41	debounce_0	0x570		0	4byte	RW	Big
42	debounce_1	0x580	MCU 版本+最高帧率+固件版本+固件日期		16byte	R	Big
43	debounce_2	0x590	2bit=0,降噪关; 2bit=1,降噪开	0	4byte	W	Big
44	line_inverter	0x5a0	8,像素位深度为 8bit 8*8Full 10,像素位深度为 10bit 10*8 80bit 12,像素位深度为 12bit 12*4 Medium 16,像素位深度为 16 *1 Base	10	4byte	W	Big
45	output_counter_i	0x5b0	2bit=0, 12bit 2bit=1, 11bit 2bit=2, 11bit 高速率	2	4byte	W	Big
46	pause	0x5c0	该模式只能在 12bit 下 切换 1 为 global reset 模式, 0 为 12bit 模式	0	4byte	W	Big
47	Frame count cleared to zero	0x5d0	该模式只能在 12bit 下 切换 1 为 2-CMS 模式, 0 为 12bit 模式	0	4byte	W	Big
48	Frame count display switch	0x5e0	HDR 计算参数	2359	4byte	W	Big
49	Dark field threshold control	0x5f0	0-16384	2657	4byte	W	Big
50	Version	0x3a0	MCU Version + maximum frame rate + Firmware version + Firmware date	4000	4byte	W	Big
51	Read mode switching	0x1f0	0-2100	100	4byte	RW	Big
52	锐化开关/等级	0x290	0: 锐化关闭 锐化等级: 1-100	0	8byte	W	Big

7.7 SDK & CLView application

7.7.1 SDK

The camera control supports two modes: 1) Controlled through private SDK development kit; 2) Controlled by GenICam interface.

7.7.2 CLView application



Figure 50 Software interface

CLView software can achieve complete control of the camera, and open source to customers to use, while providing technical support.

Description of the main functions of CLView software:

- Serial port control;
- Exposure time control;
- Gain mode control;
- ROI control;
- Frame rate control;
- Trigger mode control;
- Dark field correction control;
- TEC and Fan control;
- Refrigeration temperature control;
- Real-time frame rate display;
- Real-time temperature monitoring;
- Save picture;

Video;

Update online;

Accept customer OEM functions customized.

7.7.3 CLCtrl software

The camera can capture and display images through the software CameraLink capture card, and use the CLCtrl software to control. Start the CLCtrl software first, and then start the acquisition card software after obtaining the control of the serial port.

