The AIOCAMTOP4K Series All-in-One Camera Help Manual



Contents

Contents.....	I
1 AIOCAMTOP4K Series All-in-One Camera Application	1
2 AIOCAMTOP4K Series All-in-One Camera Datasheet and Functions	2
3 Dimension of AIOCAMTOP4K Series All-in-One Camera	4
4 AIOCAMTOP4K Series All-in-One Camera Packing Information.....	5
5 Software and App.....	6
6 AIOCAMTOP4K Series All-in-One Camera Configurations	7
6.1 Camera working standalone with built-in XCamView software	7
6.2 Connecting camera to computers with USB2.0 port	8
6.3 Camera working in WiFi mode (AP mode)	9
6.4 Connecting multi-cameras to the router through the WiFi STA mode for the network application ...	11
7 Brief Introduction of AIOCAMTOP4K UI and Its Functions	14
7.1 XCamView UI	14
7.2 The camera control panel on the left or right side of the video window	14
7.3 The Measurement Toolbar on top of the video window	15
7.4 Icons and functions of the Synthesis Camera Control Toolbar at the bottom of the video window ...	16
7.4.1 Settings>Network>General.....	16
7.4.2 Setting>Network>LAN	16
7.4.3 Settings>Network> WiFi	17
7.4.4 Settings>Measurement	18
7.4.5 Settings>Magnification.....	19
7.4.6 Settings>Image Format.....	19
7.4.7 Settings>Video	19
7.4.8 Settings>Storage	20
7.4.9 Settings>Files	20
7.4.10 Settings>Time	21
7.4.11 Settings>Language	21
7.4.12 Setting>Voice Control	21
7.4.13 Settings>Miscellaneous	22
8 Sample Photos Captured with AIOCAMTOP4K Series All-in-One Camera.....	23
9 Contacting Customer Service.....	25

1 AIOCAMTOP4K Series All-in-One Camera Application



Figure 1 The AIOCAMTOP4K Series All-in-One Camera

The [AIOCAMTOP4K](#) is a multifunctional all-in-one camera that integrates a 4K image acquisition and processing system and a 13.3-inch display screen for capturing digital images of stereo microscopes, biological microscopes, or online interactive teaching. The basic characteristic is listed as below:

- The camera and display screen are integrated together, eliminating wiring and facilitating installation
- Sony STARVIS 2 back-illuminated CMOS sensor
- Support HDMI1.4 interface connection to external displays for synchronous output, 4K/1080P auto switching according to monitor resolution
- Support USB 2.0 interface for synchronous output of real-time video
- USB flash drive for captured image and video storage, support local preview and playback
- Supports USB Voice Control module, enabling real-time control of the camera through voice commands for snap, recording, freeze, and other operations
- Excellent ISP with local tone mapping and 3D denoising
- Embedded XCamView for the control of the camera and image processing, supporting automatic edge finding and measurement functions
- ToupView/ToupLite software for PC
- iOS/Android applications for smart phones or tablets

2 AIOCAMTOP4K Series All-in-One Camera Datasheet and Functions

Order Code	Sensor & Size(mm)	Pixel(μm)	G Sensitivity Dark Signal	FPS/Resolution	Binning	Exposure(ms)
AIOCAMTOP4K8MPC	Sony IMX678(C) 1/1.8"(7.68x4.32)	2.0x2.0	1364mv with 1/30s 0.15mv with 1/30s	30@3840*2160(HDMI) 30@3840*2160(WiFi) 30@3840*2160(USB)	1x1	0.04~1000

The AIOCAMTOP4K series all-in-one camera panel interface is shown in Figure 2



Figure 2 Available Ports on the Panel of the Camera Body

Interface or Button	Function Description
USB 2.0(2)	Connect USB mouse for easy operation with embedded XCamView software Connect USB flash drive to save pictures and videos Connect 5G WiFi module to transfer video wirelessly in real time Connect USB Voice Control module, enabling real-time control of the camera through voice commands for snap, recording, freeze, and other operations
USB Video	Connect PC or other host device to realize video image transmission
ON/OFF	Power switch (Short press to turn on, long press to turn off)
HDMI OUT	Comply with HDMI1.4 standard. Used to extend 4K/1080P format video output and supporting automatic switch between 4K and 1080P format according to the connected monitors
LED	LED status indicator
+/-	Display brightness adjustment button
MENU	Display menu key
DC 12V2A	Power adapter connection (12V/2A)
Video Output Interface	Function Description
HDMI Interface	Synchronize video output through HDMI OUT interface, comply with HDMI1.4 standard; 30fps@4K Or 30fps@1080P
WiFi Interface	Connecting 5G WiFi adapter (USB2.0 slot) in AP/STA mode
USB Video Interface	Connecting USB Video port of PC for video transfer H264/MJPEG format video
Other Function	Function Description
Video Saving	Video format: 8M (3840*2160) H264/H265 encoded MP4 file Video saving frame rate: 30fps
Image Capture	8M (3840*2160) JPEG/TIFF image in USB flash drive
Measurement Saving	Measurement information saved in different layer with image content Measurement information is saved together with image content in burn in mode
ISP	Exposure(Automatic / Manual Exposure) / Gain, White Balance(Manual / Automatic / ROI Mode), Sharpening, 3D Denoise, Saturation Adjustment, Contrast Adjustment, Brightness Adjustment, Gamma Adjustment, Hue Adjustment, Color to Gray, 50HZ/60HZ Anti-flicker Function
Image Operation	Zoom In/Zoom Out (Up to 10X), Mirror/Flip, Freeze, Cross Line, Overlay, PIP, Browser (including Picture Browsing, Video Playback, Video Compare, Picture Compare, Image Processing), Measurement Function
Embedded RTC(Optional)	To support accurate time on board

The AIOCAMTOP4K Series All-in-One Camera Help Manual

Restore Factory Settings	Restore camera parameters to its factory status
Multiple Language Support	English / Simplified Chinese / Traditional Chinese / Korean / Thailand / French / German / Japanese / Italian / Russian
Software Environment under WiFi/USB Video Output	
White Balance	Auto White Balance
Color Technique	Ultra-Fine Color Engine
Capture/Control SDK	Windows/Linux/macOS/Android Multiple Platform SDK (Native C/C++, C#/VB.NET, Python, Java, DirectShow, Twain, etc)
Recording System	Still Picture or Movie
Operating System	Microsoft® Windows® 8 / 8.1 / 10 / 11(32 & 64 bit) OSx(Mac OS X) Linux
PC Requirements	CPU: Equal to Intel Core2 2.8GHz or Higher
	Memory: 4GB or More
	Ethernet Port: RJ45 Ethernet Port
	Display:19" or Larger
	CD-ROM
Operating Environment	
Operating Temperature (in Centidegree)	-10°~ 50°
Storage Temperature (in Centidegree)	-20°~ 60°
Operating Humidity	30~80%RH
Storage Humidity	10~60%RH
Power Supply	DC 12V/2A Adapter

3 Dimension of AIOCAMTOP4K Series All-in-One Camera

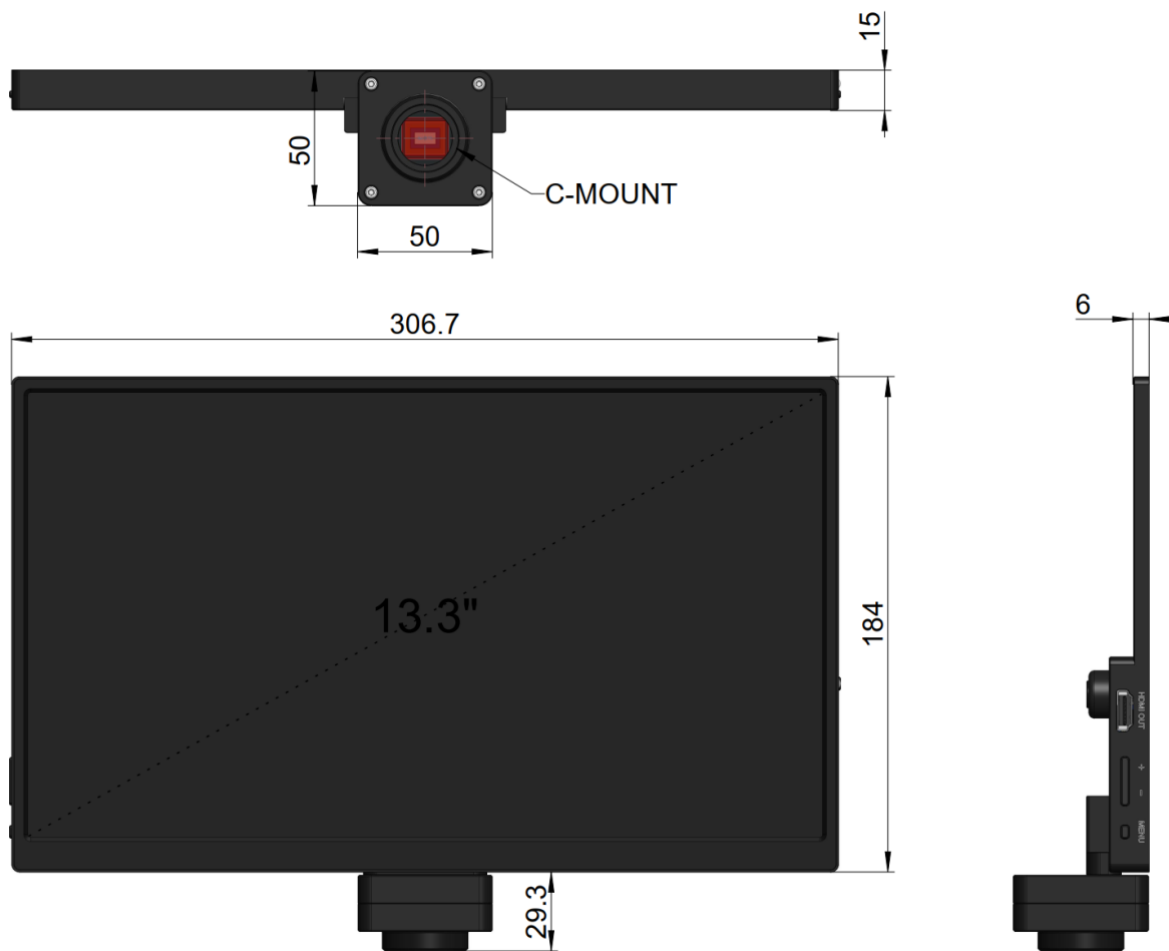

Figure 3 Dimension of AIOCAMTOP4K Series All-in-One Camera

4 AIOCAMTOP4K Series All-in-One Camera Packing Information



Figure 4 AIOCAMTOP4K Series All-in-One Camera Packing Information

Standard Packing List	
A	Gift box: L:35.6cm W:24.9cm H:7.5cm (1pcs, 1.68Kg/ box)
B	AIOCAMTOP4K Series All-in-One Camera
C	Power Adapter: Input: AC 100~240V 50Hz/60Hz, Output: DC 12V 2A American standard: Model: POWER-12V2A(MX24Z1-1202000) + American standard plug European standard: Model: POWER-12V2A(MX24Z1-1202000) + European standard plug
D	USB wireless mouse
E	USB2.0 A male to A male gold-plated connectors cable /2.0m
F	CD (Driver & utilities software, Ø12cm)
Optional Accessory	
G	HDMI Cable
H	USB flash drive
I	USB WiFi adapter
J	Voice control module (Chinese or English)

5 Software and App

The software or the APP can be downloaded from the following link:

Windows & Linux & macOS: <https://www.touptekphotonics.com.cn/download/>

iOS: [//itunes.apple.com/us/app/toupview/id911644970](https://itunes.apple.com/us/app/toupview/id911644970)

Android: <https://dl.touptekphotonics.com.cn/software/ToupView.apk>

6 AIOCAMTOP4K Series All-in-One Camera Configurations

You can use the AIOCAMTOP4K series all-in-one camera in 4 different ways. Each application requires different hardware environment.

6.1 Camera working standalone with built-in XCamView software

For this application, in addition to the microscope, all you need is the AIOCAMTOP4K series all-in-one Camera, a USB flash drive, the USB wireless mouse that came with the camera, a power adapter, and the camera's embedded [XCamView](#) software. The steps to start the camera are listed as below:



Figure 5 AIOCAMTOP4K Series All-in-One Camera with the HDMI Monitor

Insert the supplied USB mouse to the USB 2.0 interface on the right side of the AIOCAMTOP4K series all-in-one camera;

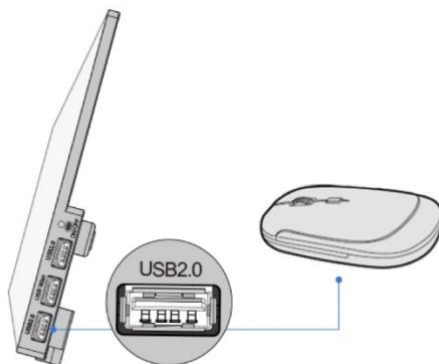

Insert the USB flash drive into the right side of the AIOCAMTOP4K series all-in-one camera USB2.0 slot;



Connect the camera to the power adapter;

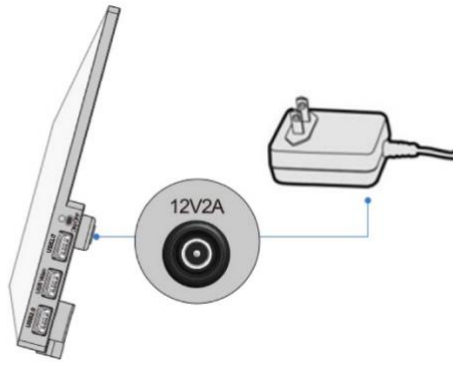

Short press the power switch on the right side of the AIOCAMTOP4K series all-in-one camera and view the video in the [XCamView](#) software. Move the mouse to the left, top or bottom of the [XCamView](#) UI, different [Control Panel](#) or [Toolbar](#) will pop up and users could operate with the mouse at ease.

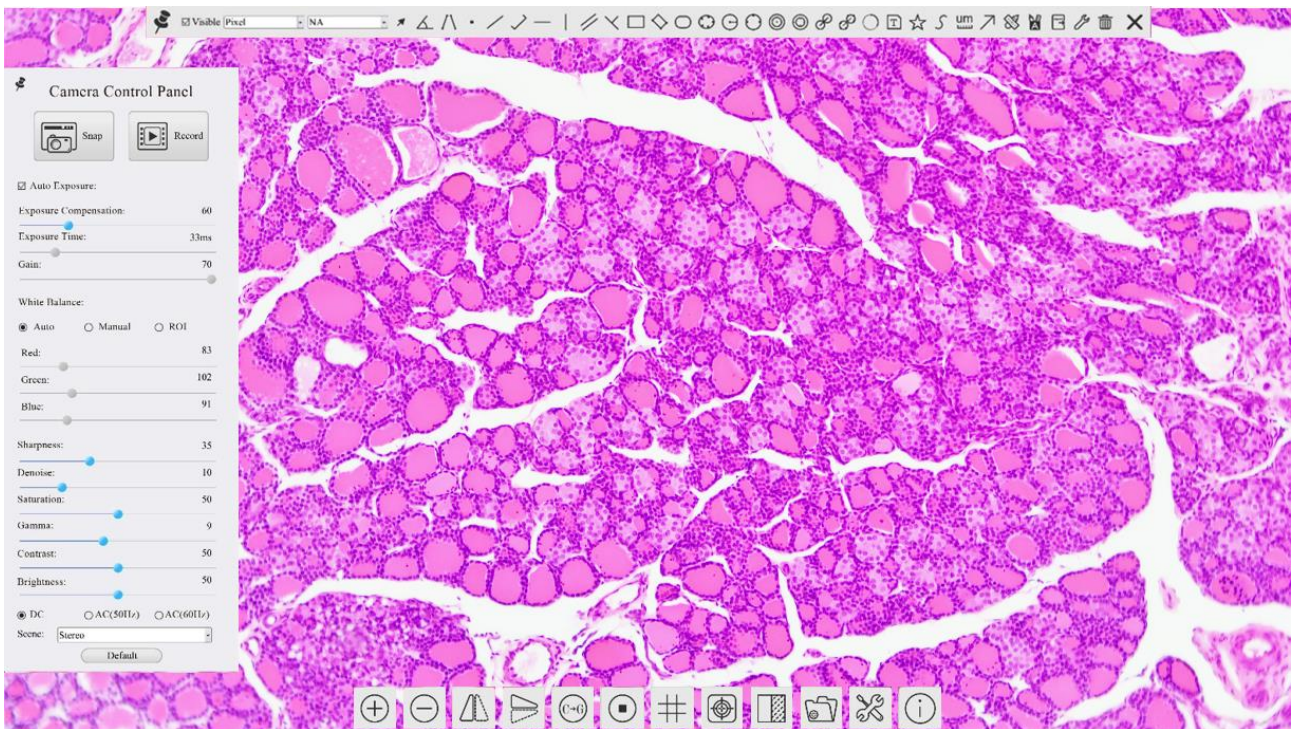

Figure 6 XCamView And AIOCAMTOP4K Series All-in-One Camera in HDMI Mode

6.2 Connecting camera to computers with USB2.0 port

For Windows user (8/10/11 (32/64 bit)), please use [ToupView](#).

For [macOS](#) and [Linux](#) user (macOS 10.10 or above or [Linux](#) distributions with kernel 2.6.27 or higher), please use [ToupLite](#). The steps to start the camera are listed below:

Start the camera according to Sec. 6.1. After the camera is running, connect camera to computer with USB cable. Please use “[USB Video](#)” slot, The upper left corner of the HDMI graphics interface displays “[USB2.0 Mode](#)”, indicating that a connection has been established with the PC.

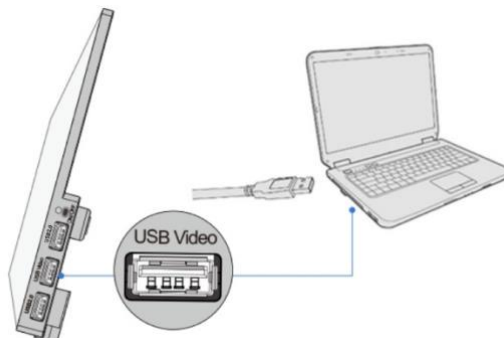

Install [ToupView/ToupLite](#) on your PC or install [ToupView App](#) on the mobile device; Run the software

ToupView/ToupLite, clicking the camera name in the **Camera List** group to start the live video as shown in Figure 7.

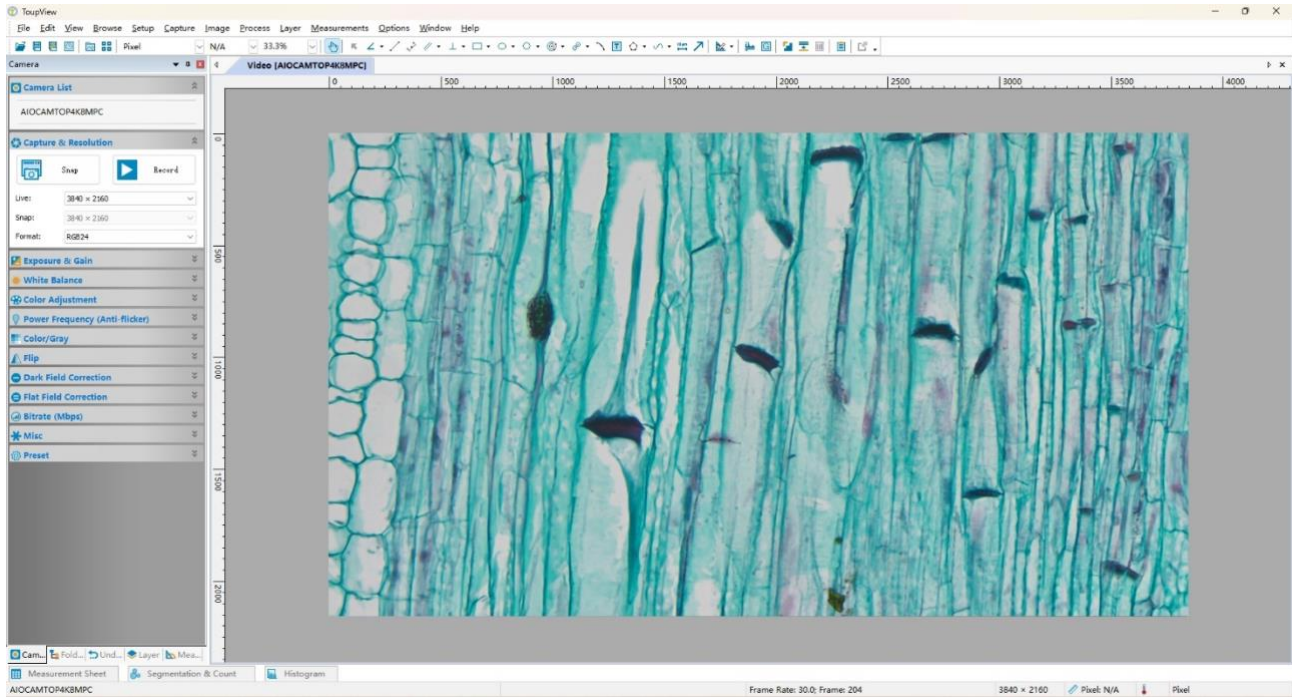

Figure 7 ToupView and AIOCAMTOP4K Series All-in-One Camera in USB Mode

6.3 Camera working in WiFi mode (AP mode)

Please make sure your PC is WiFi enabled.



Figure 8 The PC or Mobile Device Connect to the Camera through WiFi

For Windows user (Windows 8/10/10/11 (32/64 bit)), please use [ToupView](#).

For macOS and Linux user (macOS 10.10 or above or Linux distributions with kernel 2.6.27 or higher), please use [ToupLite](#). When connecting the camera with a mobile device, the free [ToupView App](#) is required. Just make sure that the mobile device uses iOS 11 or higher/Android 5.1 or higher operating systems.

The steps to start the camera are listed below:

Start the camera according to Sec. 6.1. After the camera is running, move the mouse to the bottom of the GUI and clicking the  button on the [Synthesis Camera Control Toolbar](#) at the bottom of the video window, a small window called [Settings](#) will pop up as shown below. Click [Network](#)> [WiFi](#) property page and choose the [AP](#) in the [WiFi Mode](#) edit box(The factory default configuration is [AP](#) mode).

The AIOCAMTOP4K Series All-in-One Camera Help Manual

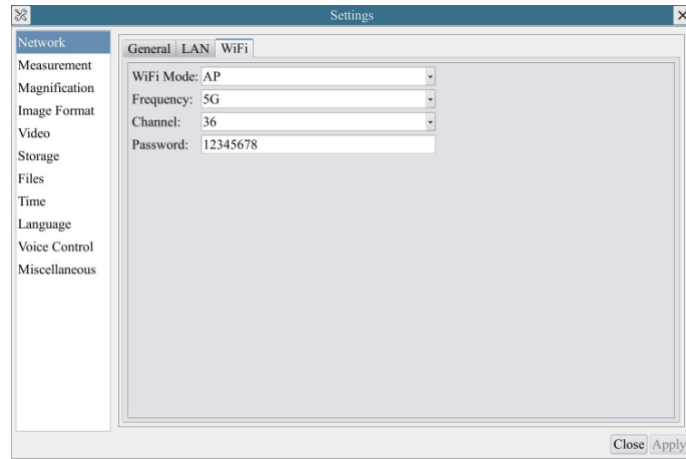

Plug the [USB WiFi](#) adapter into the camera's USB2.0 port, the upper left corner of the HDMI graphics interface will display "AP mode";

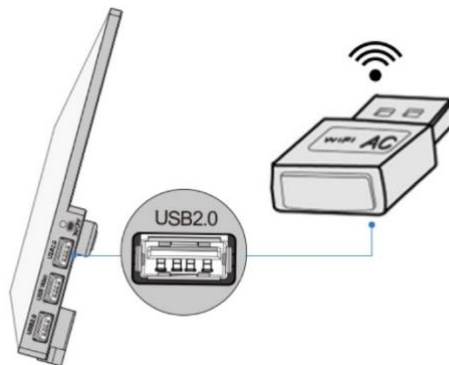

Install [ToupView/ToupLite](#) on your PC or install [ToupView App](#) on the mobile device, connect the PC or mobile device to the camera's [WiFi AP](#) point; The network name (SSID) and the [WiFi](#) password (The default one is 12345678) can be found on the camera's [Setting>Network> WiFi](#) page in [AP](#) mode.

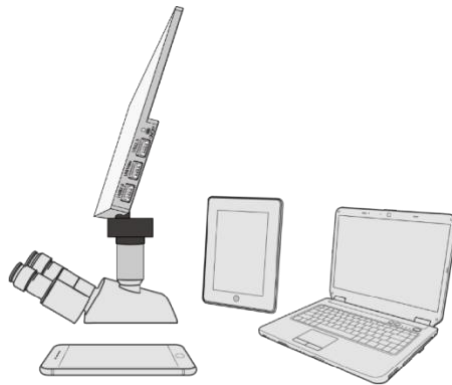

Start [ToupView/ToupLite](#) software or [ToupView App](#) and check the configuration. Normally, the active AIOCAMTOP4K series all-in-one cameras will be automatically recognized. The live image of each camera is shown in **Error! Reference source not found..** For the display, the [Camera List](#) group is used in [ToupView/ToupLite](#) software, and the [Camera Thumbnail](#) is used in [ToupView App](#).

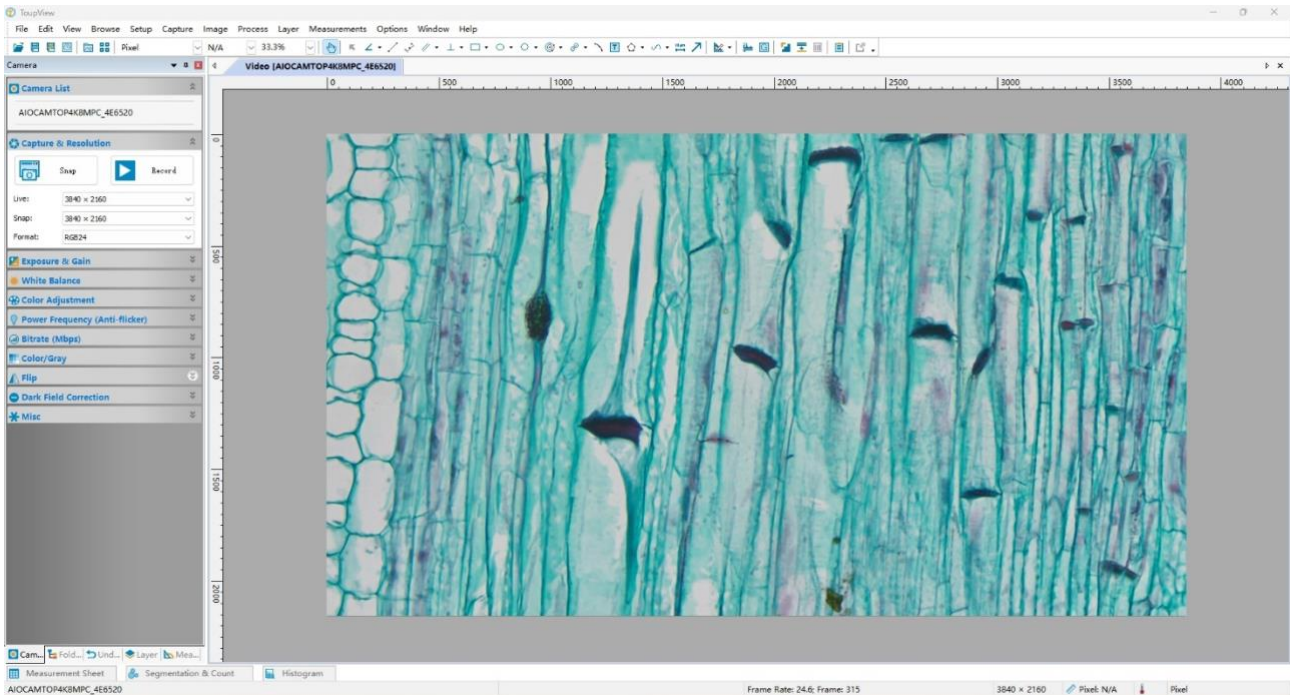



Figure 9 ToupView and AIOCAMTOP4K Series All-in-One Camera in WiFi AP Mode

6.4 Connecting multi-cameras to the router through the WiFi STA mode for the network application

Multi AIOCAMTOP4K series all-in-one cameras are connected to router through the WiFi STA mode, and the user can control the HDMI camera on the computer or mobile device through WiFi.



Figure 10 Multi AIOCAMTOP4K Series All-in-One Cameras Connecting to the Router through the WiFi Style

Start the camera according to Sec. 6.1. After the camera is running, move the mouse to the bottom of the video window and clicking the  button on the **Synthesis Camera Control Toolbar** at the bottom of the video window, a small window called **Settings** will pop up as shown below. Clicking **Network> WiFi** property page and choosing the **STA** in the **WiFi Mode** edit box (The factory default configuration is **AP** mode). Input the to be connected router's **SSID** and **Password** as shown below:

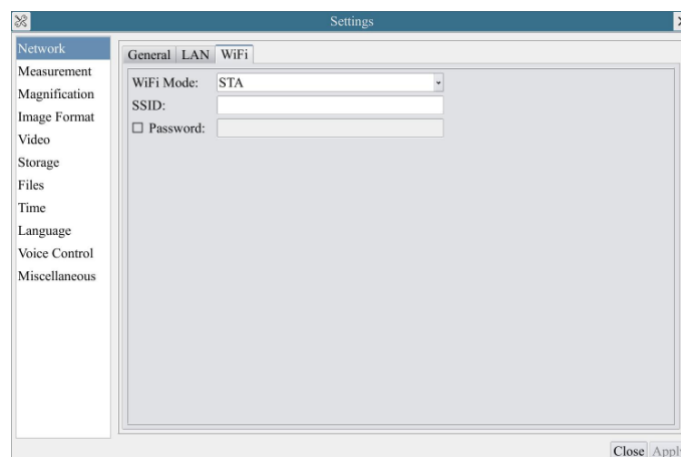

Install **ToupView /ToupLite** software on your PC. Alternatively, install the free **ToupView App** on the mobile device; Plug the **USB WiFi** adapter into the camera's USB2.0 port(for those connected to router with **WiFi STA** mode), the

upper left corner of the HDMI graphics interface will display “[STA Mode](#)” ;

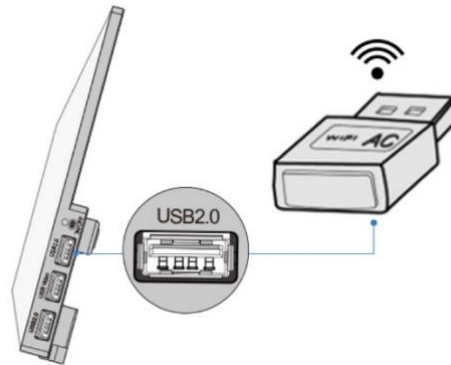

Finally, as shown below, 4 AIOCAMTOP4K series all-in-one cameras are connected to the same router with [WiFi STA](#) mode (The number of the cameras are determined by the router performance).

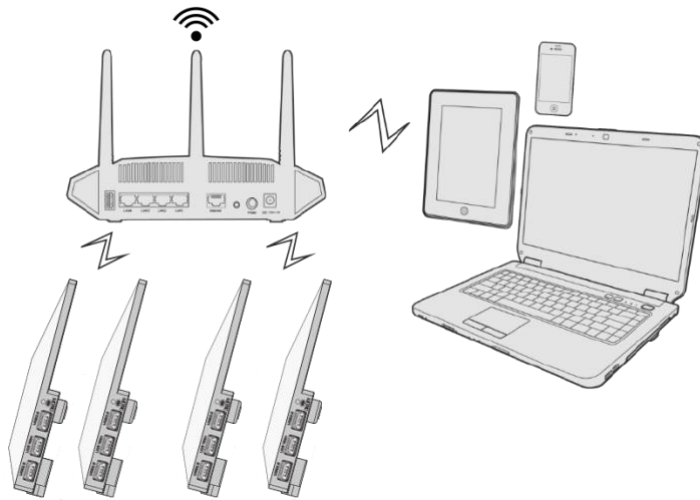

Make sure that your PC or your mobile device is connected to the [LAN](#) or [WiFi](#) of the router; Start [ToupView/ToupLite](#) software or [ToupView App](#) and check the configuration. Normally, active AIOCAMTOP4K series all-in-one cameras are automatically recognized. The live image of each camera is displayed. For the display, [Camera List](#) group is used in [ToupView/ToupLite](#) software, and [Camera Thumbnail](#) is used in [ToupView App](#); Select the AIOCAMTOP4K all-in-one series camera you are interested in. To do so, double click the camera's name in [Camera List](#) tool window if you use [ToupView /ToupLite](#) software; If you use [ToupView App](#), tap the camera's thumbnail in [Camera List](#) page(See **Error! Reference source not found.**)

[About the routers/switches](#)

It is suggested that routers/switches supporting WiFi 5G should be selected to achieve better wireless connection experience.

The AIOCAMTOP4K Series All-in-One Camera Help Manual

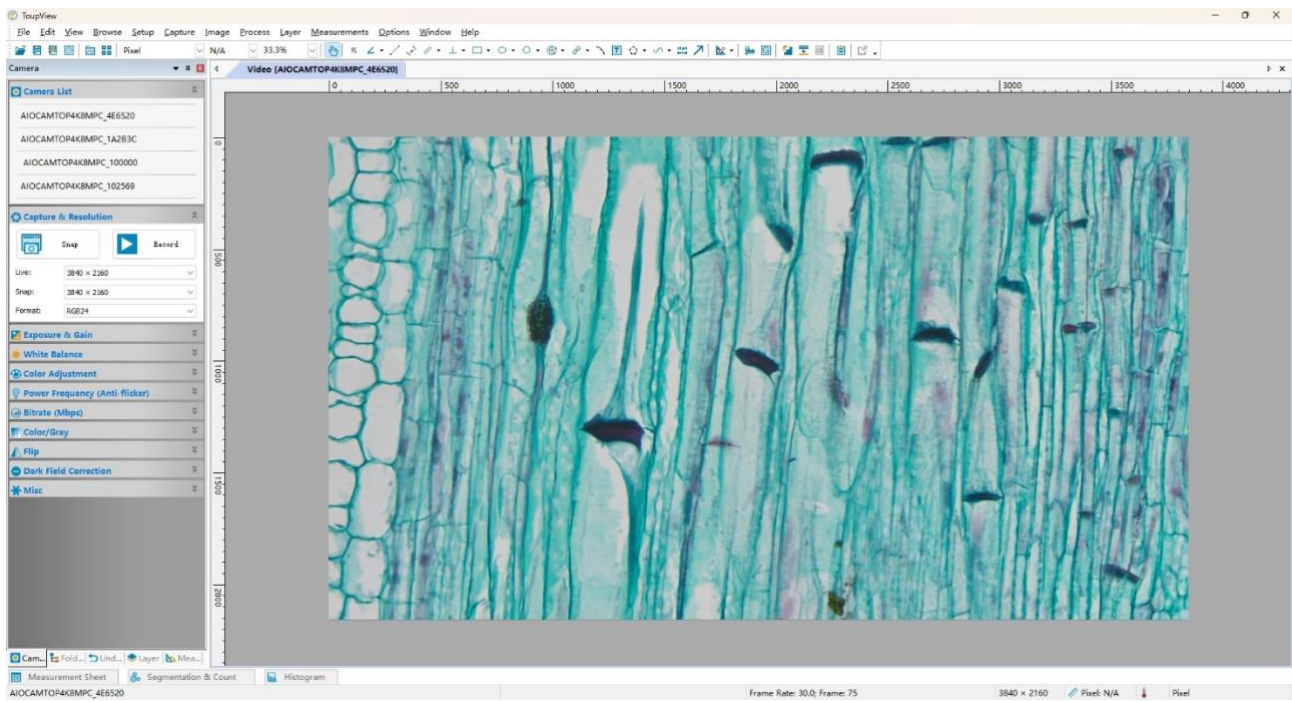









Figure 11 ToupView and AIOCAMTOP4K Series All-in-One Camera in WiFi STA mode

7 Brief Introduction of AIOCAMTOP4K UI and Its Functions

7.1 XCamView UI

The AIOCAMTOP4K UI shown in **Error! Reference source not found.** includes a **Camera Control Panel** on the left of the video window, a **Measurement Toolbar** on the top of the video window and a **Synthesis Camera Control Toolbar** on the bottom of the video window.

Notes	
1	To show the Camera Control Panel , move your mouse to the left or right of the video window. See Sec.7.2 for details
2	Move the mouse cursor to the top of the video window, a Measurement Toolbar will pop up for calibration and measurement operations. When user left-clicks the Float/Fixed button  on the Measurement Toolbar , the Measurement Toolbar will be fixed. In this case the Camera Control Panel will not pop up automatically even if users move mouse cursor to left or right side of the video window. Only when user left-clicks the X button on the Measurement Toolbar to exit from measuring procedure will they be able to do other operations on the Camera Control Panel, or the Synthesis Camera Control Toolbar . During the measuring process, when a specific measuring object is selected, an Object Location & Attributes Control Bar       will appear for changing location and properties of the selected object. See Sec.7.3 for details.
3	When users move mouse cursor to the bottom of the video window, the Synthesis Camera Control Toolbar will pop up automatically.  See Sec.7.4 for details.

7.2 The camera control panel on the left or right side of the video window

The **Camera Control Panel** controls the camera to achieve the best video or image quality according to the specific applications; It will pop up automatically when the mouse cursor is moved to the left or right side of the video window (in measurement status, the **Camera Control Panel** will not pop up. The **Camera Control Panel** will only pop up when the measurement process is finished or terminated while user's cursor on the left edge of the video window). Left-clicking  button to achieve **Display/Auto Hide** switch of the **Camera Control Panel**.

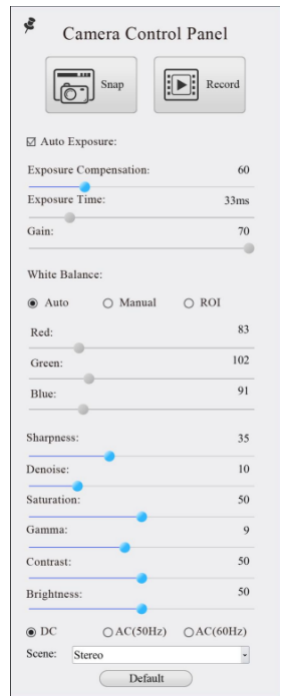
Camera Control Panel	Function	Function Description
	Snap	Capture image and save it to the USB flash drive
	Record	Record video and save it to the USB flash drive
	Auto Exposure	When Auto Exposure is checked, the system will automatically adjust exposure time and gain according to the value of exposure compensation
	Exposure Compensation	Available when Auto Exposure is checked. Slide to left or right to adjust Exposure Compensation according to the current video brightness to achieve proper brightness value
	Exposure Time	Available when Auto Exposure is unchecked. Slide to left or right to reduce or increase exposure time, adjusting brightness of the video
	Gain	Adjust Gain to reduce or increase brightness of video. The Noise will be reduced or increased accordingly
	Red	Slide to left or right to decrease or increase the proportion of Red in RGB on video
	Green	Slide to left or right to decrease or increase the proportion of Green in RGB on video
	Blue	Slide to left or right to decrease or increase the proportion of Blue in RGB on the video
	Auto	White Balance adjustment according to the window video every time the button is clicked
	Manual	Adjust the Red 、 Green or Blue item to set the video White Balance
	ROI	Check the ROI item will display a red ROI rectangle on the video window, drag it to the interested area will perform the White Balance according to the area video data
	Sharpness	Adjust Sharpness level of the video
	Denoise	Slide left or right to Denoise the video
	Saturation	Adjust Saturation level of the video
	Gamma	Adjust Gamma level of the video. Slide to the right side to increase Gamma and to the left to decrease Gamma .
	Contrast	Adjust Contrast level of the video. Slide to the right side to increase Contrast and to the left to decrease Contrast .
	Brightness	Adjust Brightness level of the video. Slide to the right side to increase Brightness and to the left to decrease Brightness .
	DC	For DC illumination, there will be no fluctuation in light source so no need for compensating light flickering
	AC(50HZ)	Check AC (50HZ) to eliminate flickering caused by 50HZ illumination
AC(60HZ)	Check AC (60HZ) to eliminate flickering caused by 60HZ illumination	
Scene	Select different default parameters according to the type of microscope	
Default	Restore all the settings in the Camera Control Panel to default values	

7.3 The Measurement Toolbar on top of the video window

The **Measurement Toolbar** will pop up when moving mouse cursor to any place near the upper edge of the video window. Here is the introduction of the various functions on the **Measurement Toolbar**:

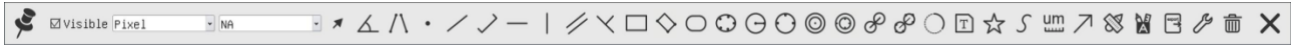







Figure 12 The Measurement Toolbar on the Upper Side of the Video Window

Icon	Function
	Float/ Fix switch of the Measurement Toolbar
<input checked="" type="checkbox"/> Visible	Show / Hide Measurement Objects
Pixel	Select the desired Measurement Unit
NA	Select Magnification for Measurement after Calibration
	Object Select
	Angle
	4 Points Angle
	Point (Point Counter)
	Arbitrary Line
	3 Points Line
	Horizontal Line
	Vertical Line
	3 Points Vertical Line
	Parallel
	Rectangle
	3 Points Rectangle
	Ellipse
	5 Points Ellipse
	Circle
	3 Points Circle
	Annulus
	3 Points Annulus
	Two Circles and its Center Distance
	3 Points Two Circles and its Center Distance
	Arc
	Text
	Polygon
	Curve
	Scale Bar
	Arrow
	Execute Calibration to determine the corresponding relation between magnification and resolution, which will establish the corresponding relationship between measurement unit and the sensor pixel size. Calibration needs to be done with the help of a micrometer. For detailed steps of carrying out Calibration please refer to ToupView help manual.
	Auto Measurement: Two Points Parallel, Circle Detect, Annulus Detect, Rectangle Detect
	Export the Measurement information to CSV file(*.csv)
	Measurement Setup
	Delete all the measurement objects
	Exit from Measurement mode
	When the measurement ends, left-click on a single measuring object and the Object Location & Properties Control Bar will show up. User could move the object by dragging the object with the mouse. But more accurate movement could be done with the control bar. The icons on the control bar mean Move Left , Move Right , Move Up , Move Down , Color Adjustment and Delete .

Note:













1) When user left-clicks **Display/Hide** button on **Measurement Toolbar**, **Measurement Toolbar** will be fixed. In this case **Camera Control Panel** will not pop up automatically even if moving the mouse cursor to the left edge of the

video window. Only when user left-click the **X** button on **Measurement Toolbar** to exit from the measurement mode will they be able to doing other operations on **Camera Control Panel** or **Synthesis Camera Control Toolbar**.

2) When a specific **Measurement Object** is selected during the measurement process, **Object Location & Attributes Control Bar**       will appear for changing the object location and properties of the selected objects.

7.4 Icons and functions of the Synthesis Camera Control Toolbar at the bottom of the video window



Icon	Function	Icon	Function
	Zoom In the Video Window		Zoom Out the Video Window
	Horizontal Flip		Vertical Flip
	Color/gray		Video Freeze
	Display Cross Line		Image Overlay
	PIP		Browse images and videos in the USB flash drive
	Settings		Check the Version of XCamView

The  **Setting** function, for detailed introduction, please refer to Sections 7.4.1 to 7.4.13.

7.4.1 Settings>Network>General

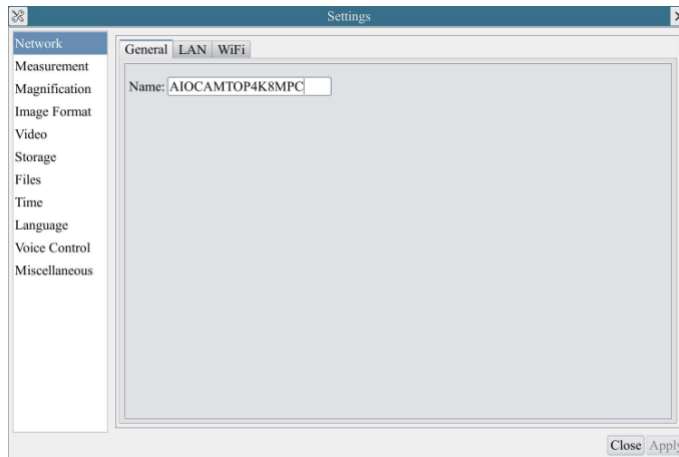

Figure 13 Comprehensive Network General Settings Page

Name	The current camera name recognized as the network name
-------------	--

7.4.2 Setting>Network>LAN

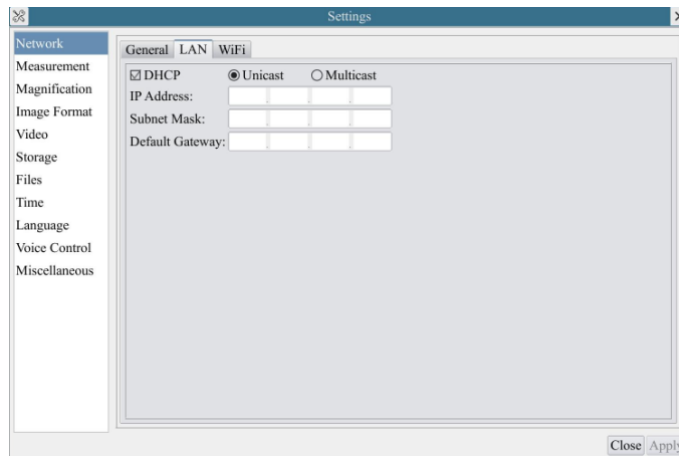

Figure 14 Comprehensive Network LAN Settings Page

DHCP	Dynamic host control protocol allows DHCP server to automatically assign IP information to the camera. Only in Sec6.4 LAN networking this item should be checked, so that cameras can automatically get IP information from routers/switches to facilitate networking operation;
Unicast/Multicast	By default, unicast function is used. Only in Sec 6.4 networking environment, when the router/switch has multicast function, camera can switch to multicast mode, which can save the network bandwidth consumed by the camera and facilitate the connection of more cameras in the same network;

The AIOCAMTOP4K Series All-in-One Camera Help Manual

<p>IP Address</p>	<p>Every machine on a network has a unique identifier. Just as you would address a letter to send in the mail, computers use the unique identifier to send data to specific computers on a network. Most networks today, including all computers on the Internet, use the TCP/IP protocol as the standard for how to communicate on the network. In the TCP/IP protocol, the unique identifier for a computer is called IP address.</p> <p>There are two standards for IP address: IP Version 4 (IPv4) and IP Version 6 (IPv6). All computers with IP addresses have an IPv4 address, and many are starting to use the new IPv6 address system as well.</p> <p>Users must manually configure their IP addresses on the camera side and computer side. The IP addresses set on the camera side and computer side should be in the same network segment. The specific settings are shown Error! Reference source not found. It's usually a private address. Private address is a non-registered address used exclusively within an organization. The internal private addresses retained are listed below: Class A 10.0.0-10.255.255; Class B 172.16.0-172.31.255.255; Class C 192.168.0-192.168.255.255. The suggested IP address is Class C.</p>
<p>Subnet Mask</p>	<p>Subnet Mask is used to distinguish network domain from host domain in 32-bit IP address;</p>
<p>Default Gateway</p>	<p>A default gateway allows computers on a network to communicate with computers on another network. Without it, the network is isolated from the outside. Basically, computers send data that is bound for other networks (one that does not belong to its local IP range) through the default gateway;</p> <p>Network administrators configure the computer's routing capability with an IP range's starting address as the default gateway and point all clients to that IP address.</p>

Uncheck the **DHCP** and select the **Unicast** item, user still need to set the **IP address**, **Subnet mask** and **Default Gateway** as shown below:

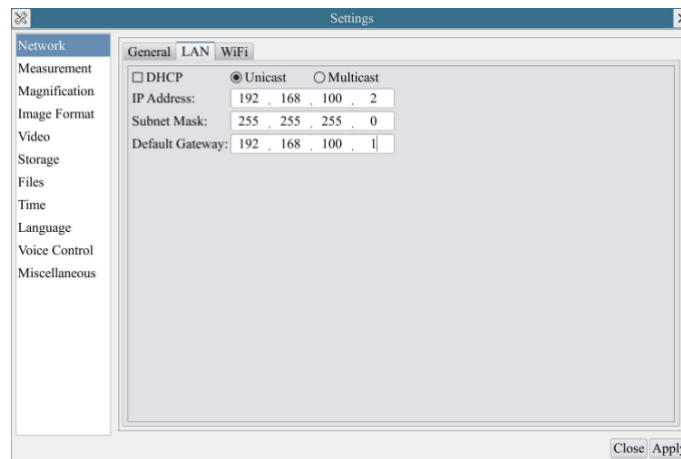

Figure 15 Manual DHCP and Unicast

Uncheck the **DHCP** and select the **Multicast** item, user still need to set the **IP address**, **Subnet Mask** and **Default Gateway** as shown below:

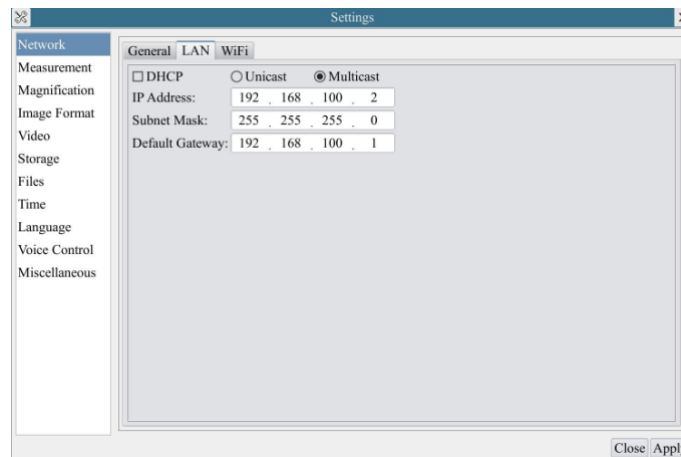

Figure 16 Manual DHCP and Multicast

7.4.3 Settings>Network> WiFi

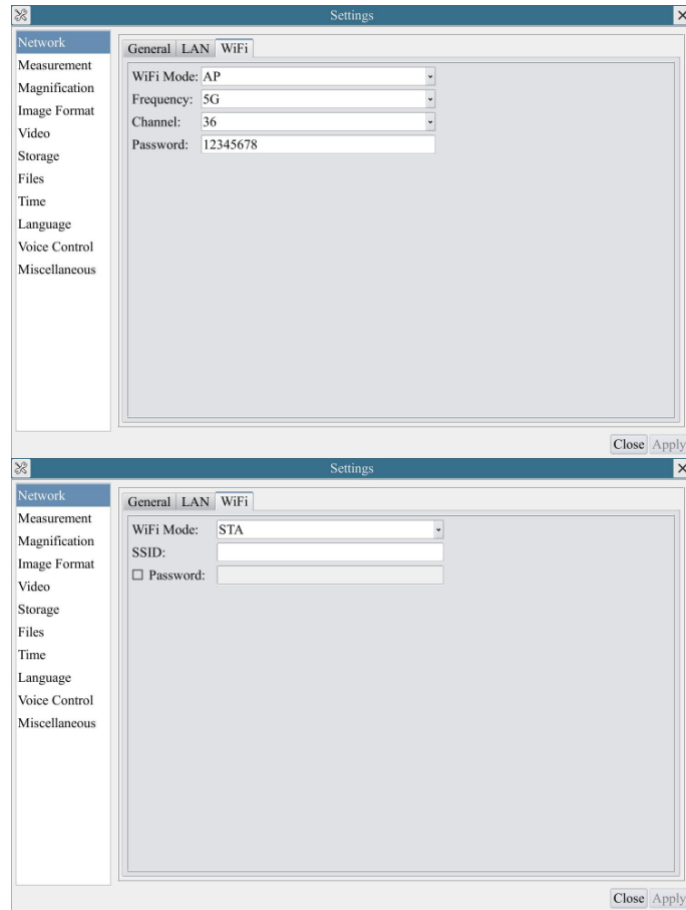

Figure 17 Network Setup

Wi-Fi Mode	AP/STA mode to select;
Channel/SSID	Channel for the AP mode and SSID for the STA mode. Here, the SSID is the router's SSID ;
Password	Camera Password for the AP mode. Router Password for the STA mode

7.4.4 Settings>Measurement

This page is used for the define of the [Measurement Object](#) properties.

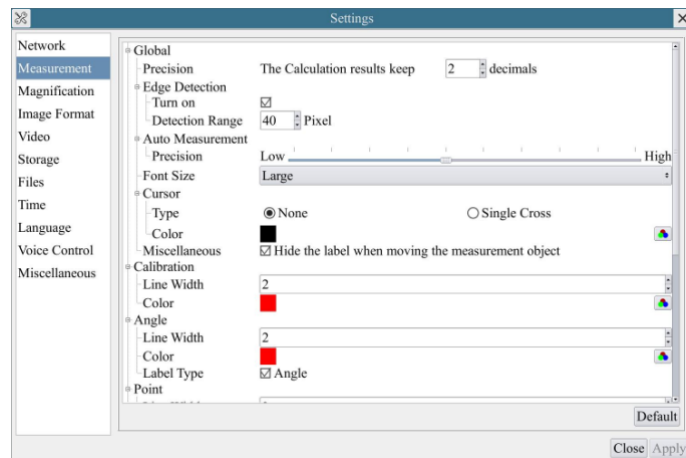



Figure 18 The Measurement Setup

Global	Precision	Used for setting digits behind the decimal point for measurement results;
	Edge Detection	Select whether to enable the automatic edge search function and set the detection range;
	Auto Measurement	Used for define the level of accuracy used for auto measurement;
	Font Size	The font size of measurement data can be divided into three types: large, Middle, and Small;
	Cursor	Select whether the cursor is a single crosshair and set the color of the single cross;
	Miscellaneous	Whether to hide the label when moving the measurement objects;
Calibration	Line Width	Used for defining width of the lines for calibration;
	Color	Used for defining color of the lines for calibration;

	EndPoint	Type: Used for defining shape of the endpoints of lines for calibration: Null means no EndPoint, rectangle means rectangle type of endpoints. It makes alignment more easily;
Point, Angle, Line, Horizontal Line, Vertical Line, Rectangle, Circle, Ellipse, Annulus, Two Circles, Polygon, Curve		
	Left-click the  along with the Measurement command mentioned above will unfold the corresponding attribute settings to set the individual property of the Measurement Objects .	

7.4.5 Settings>Magnification

This page's items are formed by the **Measurement Toolbar's Calibration** command.

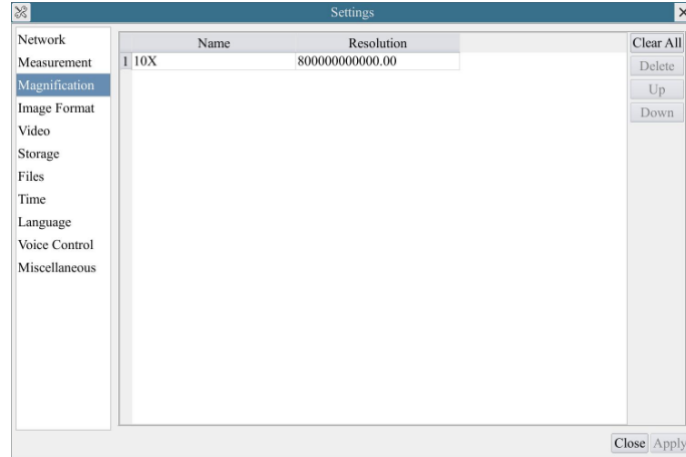

Figure 19 Comprehensive Magnification Settings Page

Name	Names such as 10X, 40X, 100X are based on magnification of the microscopes. For continuous zoom microscopes, ensure that the selected magnification coincides with the scale alignment line on the microscope zoom knob; Users could also edit the name of the magnification with other information, for example, microscope mode, users name, etc.
Resolution	Pixels per meter. Image device like microscopes have high Resolution value;
Clear All	Click the Clear All button will clear the calibrated magnifications;
Delete	Click Delete to delete the selected magnification;
Up	Select a row in the magnification and click Move Up to move up the currently selected magnification;
Down	Select a row in the magnification and click Move Down to move up the currently selected magnification;

7.4.6 Settings>Image Format

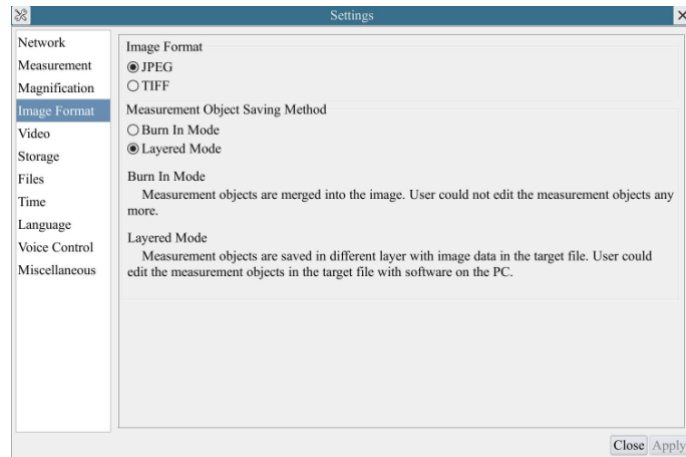

Figure 20 Comprehensive Image Format Settings Page

Image Format	JPEG: The extension of JPEG file can get very high compression rate and display very rich and vivid images by removing redundant images and color data. In other words, it can get better image quality with the least disk space. If measurement objects are available, the measurement objects will be burned into the image and the measurement cannot be edited. TIFF: TIFF is a flexible bitmap format mainly used to store images including photos and artistic images.
Measurement Object Saving Method	Burn in Mode: The measurement objects are merged into the current image. User could not edit the measurement objects any more. This mode is not reversible. Layered Mode: The measurement objects are saved in different layer with current image data in the target file. User could edit the measurement objects in the target file with some software on the PC. This mode is reversible.

7.4.7 Settings>Video

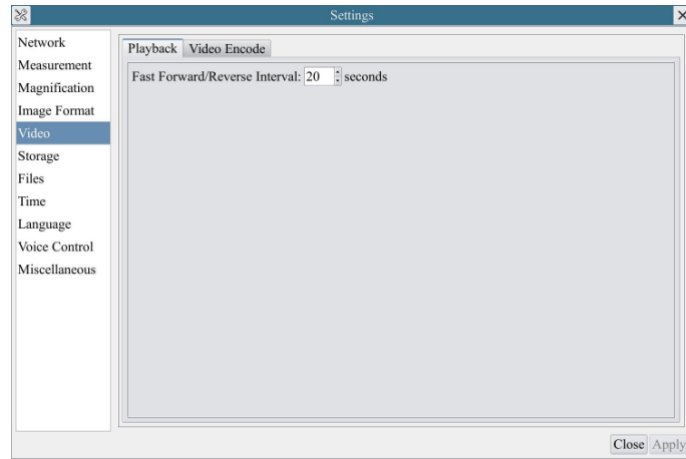

Figure 21 Comprehensive Setting of Video page

Video Playback	Fast Forward/Reverse interval in second unite for Video Playback
Video Encode	Select the Video Encode format. Can be H264 or H265. Compared with H264, H265 has a higher H265 compression ratio which is primarily used to further reduce the design flow rate, in order to lower the cost of storage and transmission

7.4.8 Settings>Storage

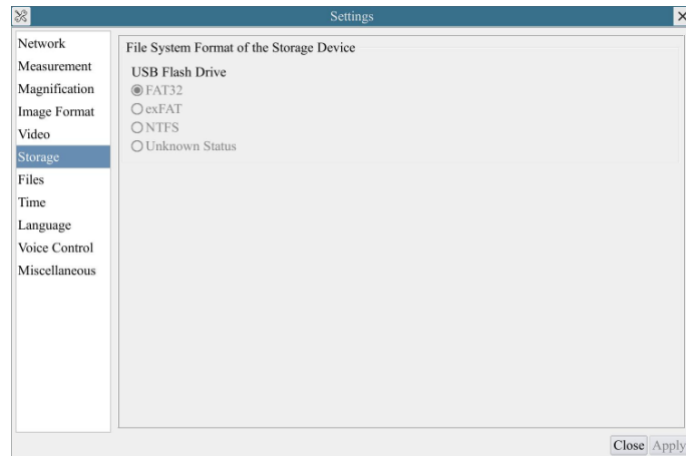

Figure 22 Comprehensive Setting of Storage Page

File System Format of the Storage Device	<p>List the file system format of the current storage device</p> <p>FAT32: The file system of USB Flash Drive is FAT32. The maximum video file size of single file in FAT32 file system is 4G Bytes;</p> <p>exFAT: The file system of USB Flash Drive is exFAT. The maximum video file size of single file in FAT32 file system is 16E Bytes;</p> <p>NTFS: The file system of USB Flash Drive is NTFS. The maximum video file size of single file is 2T Bytes.</p> <p>Unknown Status: USB Flash Drive not detected or the file system is not identified;</p> <p>Note: For USB Flash Drive, USB 3.0 interface is preferred.</p>
--	---

7.4.9 Settings>Files

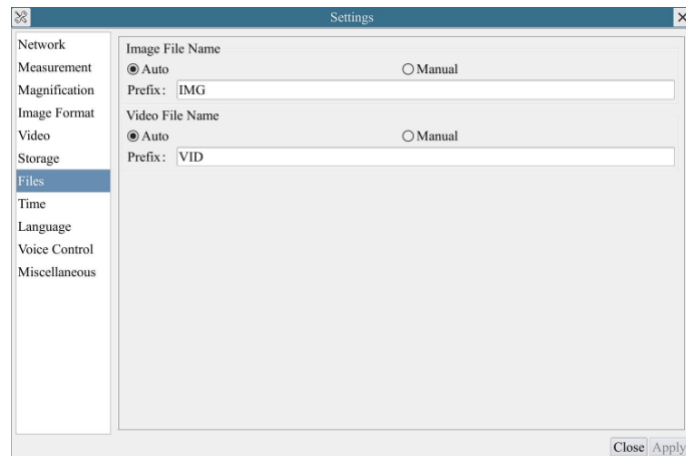

Figure 23 Comprehensive Setting of Files Name

Image or Video File Name Paradigm	Provide Auto or Manual naming paradigm for Image or Video file;
Auto	With specified name as the Prefix and XCamView will add digital after the Prefix for the Image or Video file;
Manual	A file dialog will pop up to enter the Image or Video file name for the captured Image or Video .

7.4.10 Settings>Time

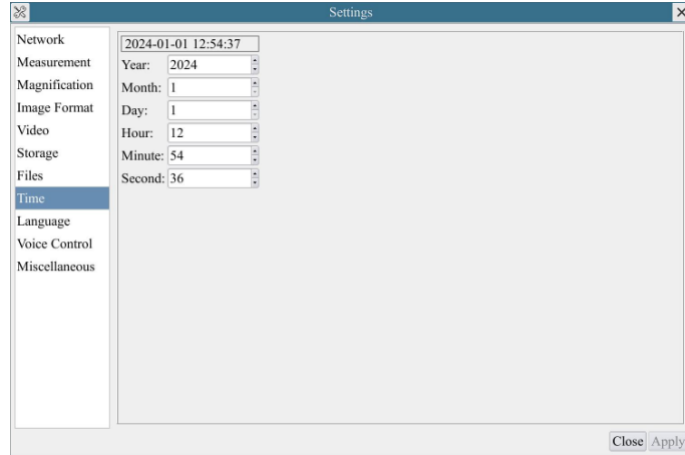

Figure 24 Time Setting

Time	User can set Year , Month , Day , Hour , Minute and Second in this page.
----------------------	--

7.4.11 Settings>Language



Figure 25 Comprehensive Setting of Language Selection Setting Page

English	Set language of the whole software into English;
Simplified Chinese	Set language of the whole software into Simplified Chinese;
Traditional Chinese	Set language of the whole software into Traditional Chinese;
Korean:	Set language of the whole software into Korean;
Thailand	Set language of the whole software into Thailand;
French	Set language of the whole software into French;
German	Set language of the whole software into German;
Japanese	Set language of the whole software into Japanese;
Italian	Set language of the whole software into Italian;
Russian	Set language of the whole software into Russian;

7.4.12 Setting>Voice Control

The AIOCAMTOP4K Series All-in-One Camera Help Manual

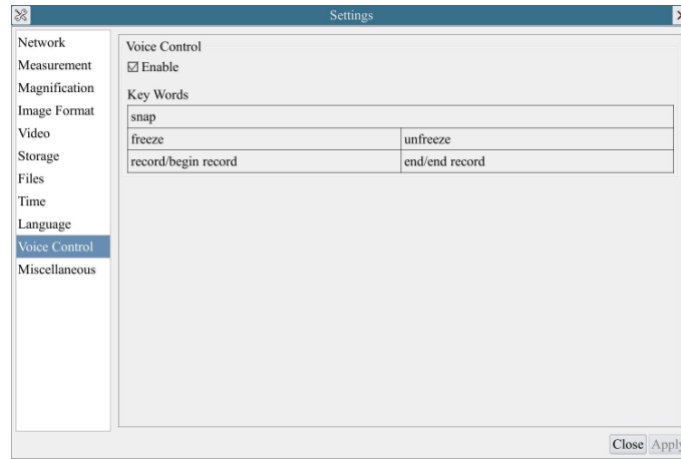

Figure 26 Comprehensive Setting of Voice Control

Voice Control	Select whether to enable or not;
Key Words	Provide Key Words for “snap”;
	Provide Key Words for “freeze”, “unfreeze”;
	Provide Key Words for “record/begin record”, “end/end record”;
Note: After the camera is turned on, if the voice control module is not plugged in, the Key Words information will not be displayed by default;	

7.4.13 Settings>Miscellaneous

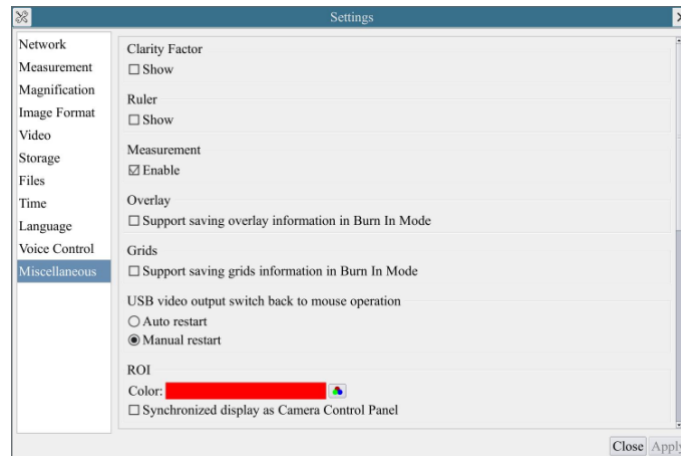

Figure 27 Comprehensive Miscellaneous Settings Page

Clarity Factor	Select to display the ruler in the video window, otherwise not to display the Clarity Factor . You can choose the Clarity Factor ;
Ruler	Select to display the ruler in the video window, otherwise not to display the ruler. You can choose the ruler color;
Measurement	Select to display the measurement toolbar in the video window, otherwise not to display the measurement toolbar;
Overlay	Select to support saving graphics overlay information in fusion mode, otherwise it will not support;
Grids	Select to support saving mesh information in fusion mode, otherwise not to support;
USB Video Output Switch Back to Mouse Operation	Select to support USB video output and switch the mouse to automatic restart or manual restart;
ROI	Select ROI color as the color that the customer wants to set;
Cursor	Choosing the Cursor size according to the screen resolution or personal preference
Camera Control Panel Display Location	Select the camera control panel to display on the left, right, or both sides of the HDMI interface;
Camera Parameters Import	Import the Camera Parameters from the USB flash drive to use the previously exported Camera Parameters
Camera Parameters Export	Export the Camera Parameters to the USB flash drive to use the previously exported Camera Parameters
Reset to factory defaults	Restore camera parameters to its factory status;

8 Sample Photos Captured with AIOCAMTOP4K Series All-in-One Camera

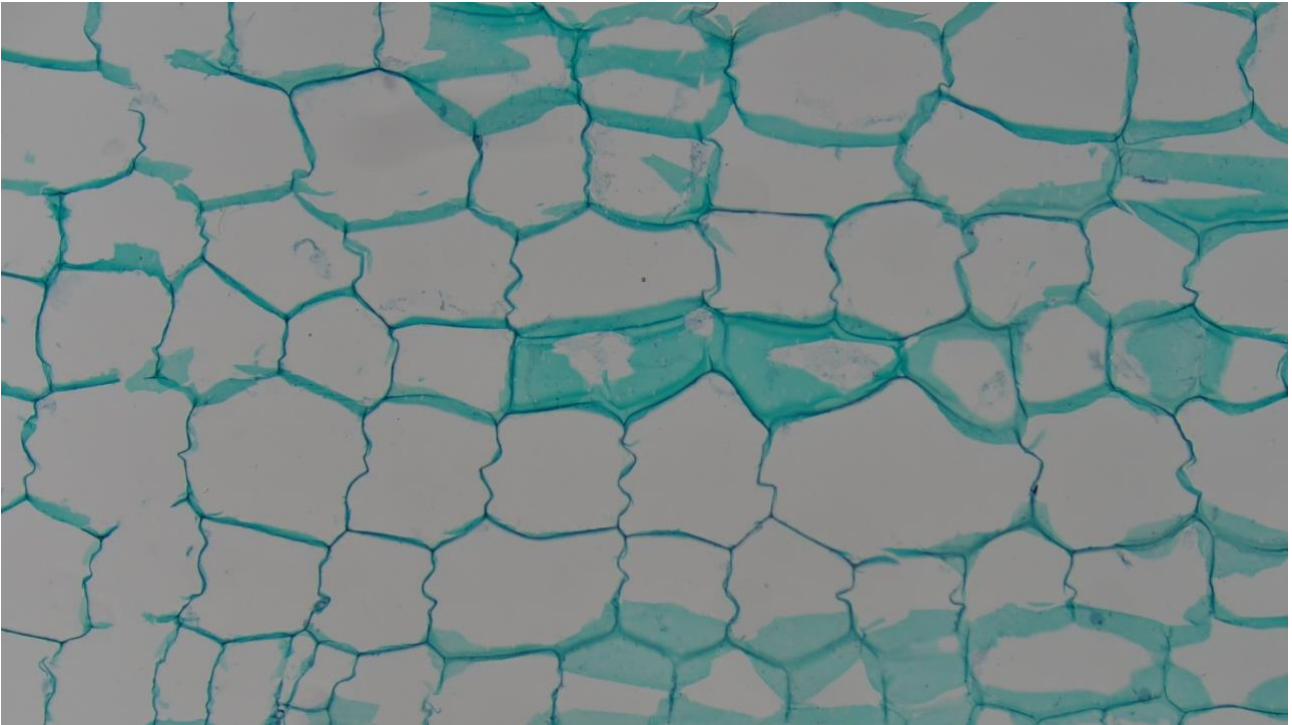

Figure 28 Cucurbit Stem.L.S.Captured with AIOCAMTOP4K8MPC

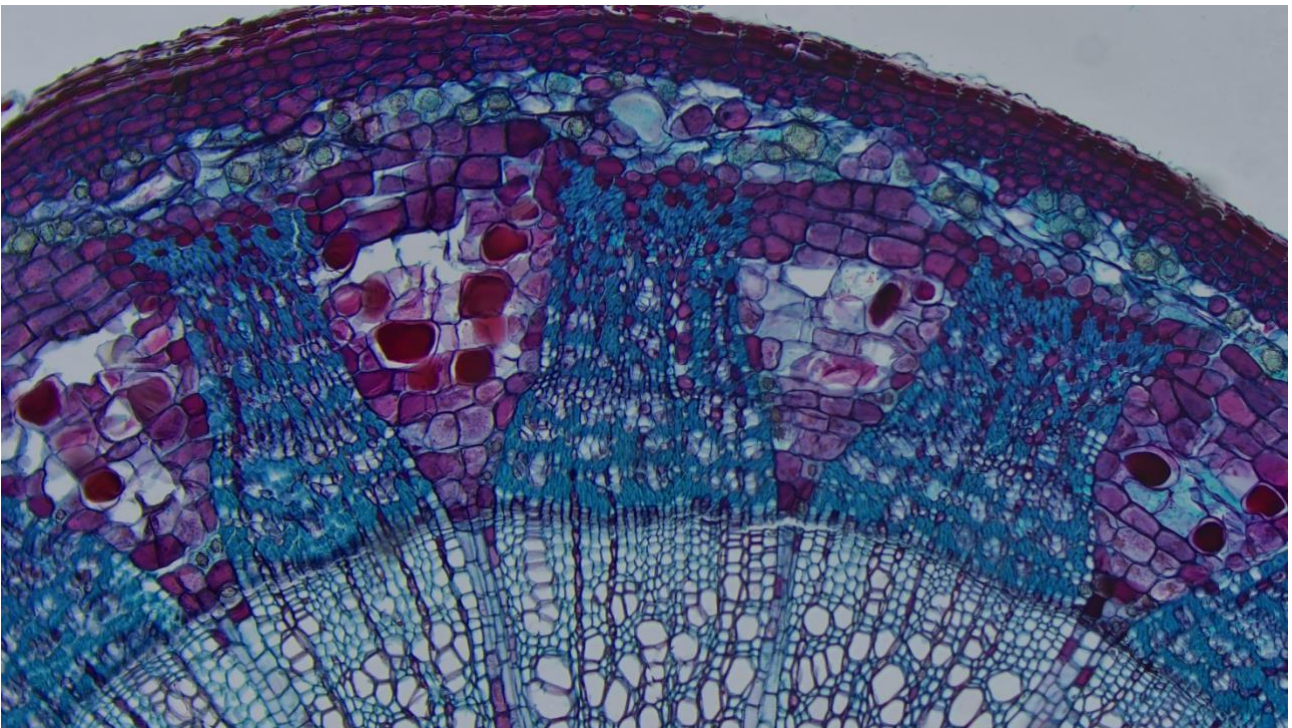

Figure 29 Two Year Tilia Stem.C.S. Captured with AIOCAMTOP4K8MPC

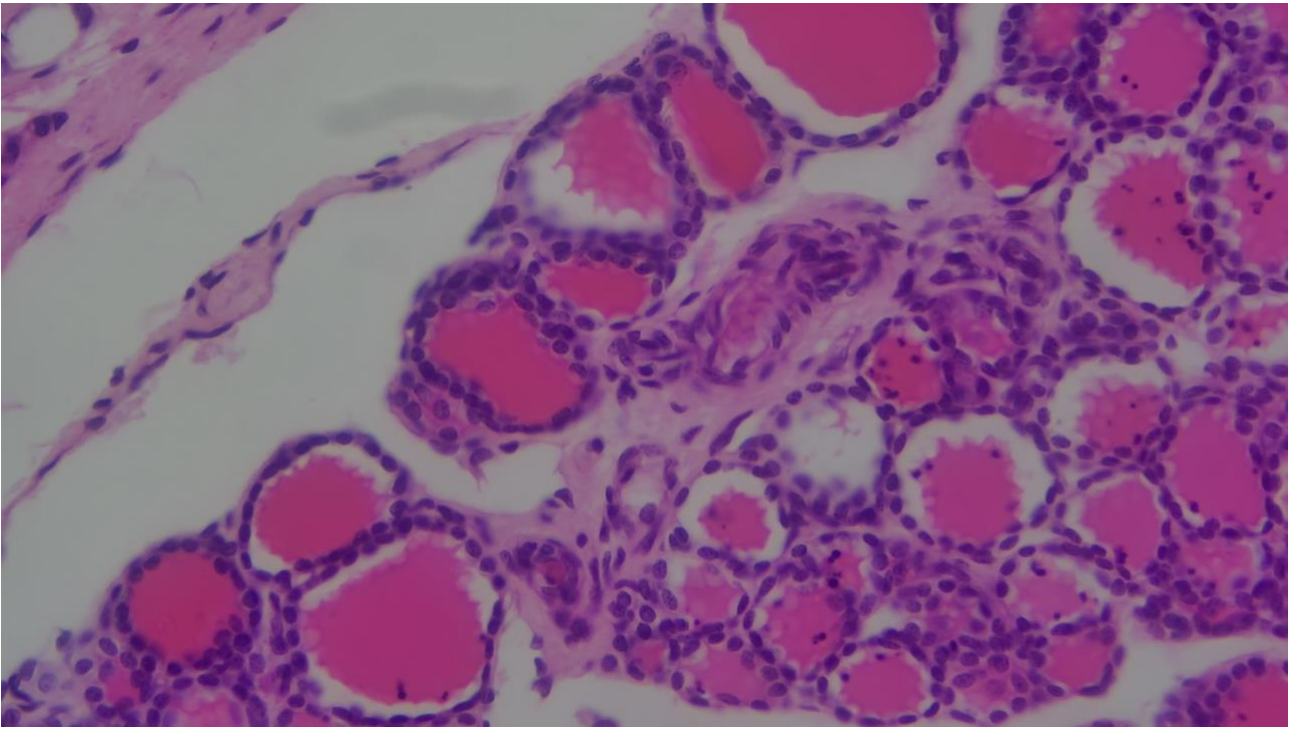

Figure 30 Simple Cuboidal Epithelium.Sec.with AIOCAMTOP4K8MPC

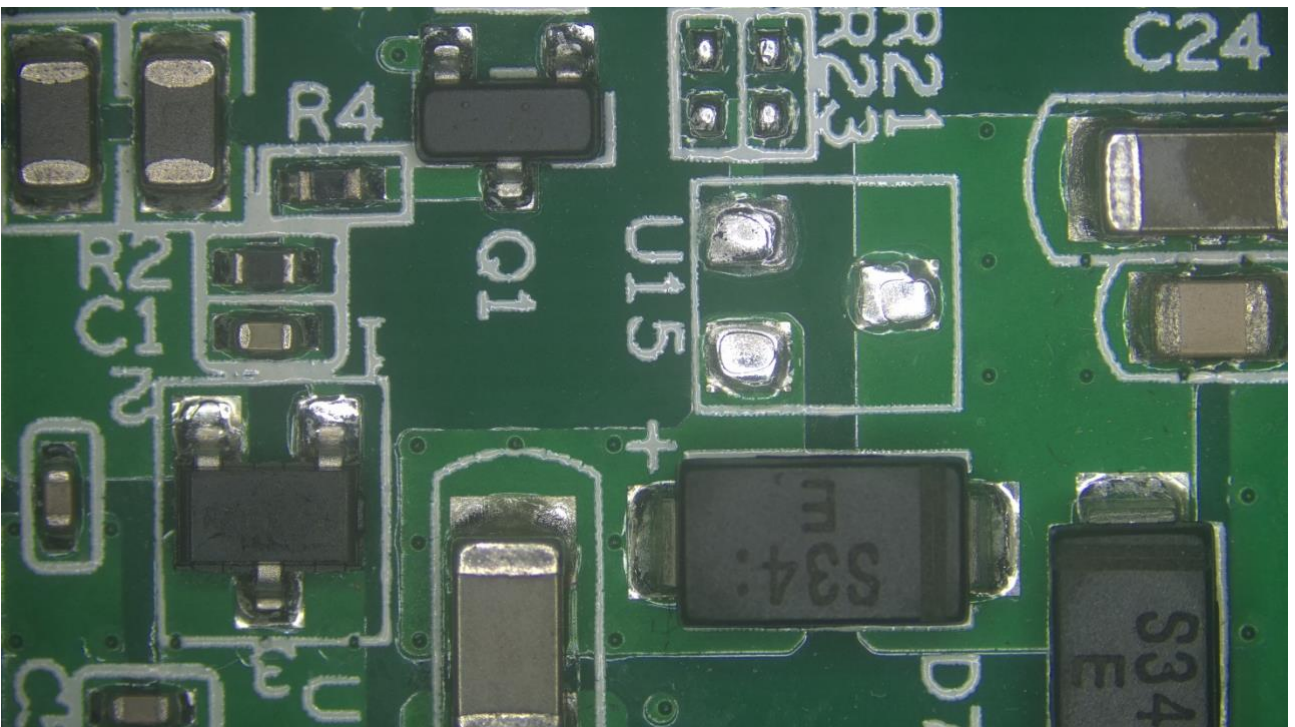

Figure 31 Circuit Board Captured with AIOCAMTOP4K8MPC

9 Contacting Customer Service

Please contact your local distributor if you have any questions about the product.